

# English Made Easy

Learning English through Pictures

## VOLUME ONE



Jonathan Crichton  
and  
Pieter Koster

TUTTLE

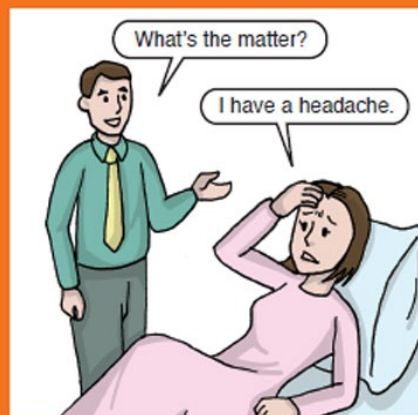

# English Made Easy

Learning English Through Pictures

VOLUME ONE

By Jonathan Crichton and Pieter Koster



TUTTLE Publishing  
Tokyo | Rutland | Vermont Singapore

Published by Tuttle Publishing, an imprint of Periplus Editions (HK) Ltd.

[www.tuttlepublishing.com](http://www.tuttlepublishing.com)

Copyright © 2006 Periplus Editions (HK) Ltd.

All rights reserved. No part of this book may be reproduced or utilized in any form or by any means, electronic or mechanical, including photocopying, recording, or by any information storage or retrieval system, without permission in writing from the publisher.

LCC Card NO. 2006282280

ISBN: 978-1-4629-0557-7 (ebook)

Distributed by:

**North America, Latin America & Europe**

Tuttle Publishing  
364 Innovation Drive  
North Clarendon,  
VT 05759-9436 U.S.A.  
Tel: 1 (802) 773-8930  
Fax: 1 (802) 773-6993  
info@tuttlepublishing.com  
[www.tuttlepublishing.com](http://www.tuttlepublishing.com)

**Japan**

Tuttle Publishing  
Yaekari Building, 3rd Floor  
5-4-12 Osaki, Shinagawa-ku,  
Tokyo 141 0032  
Tel: (81) 3 5437-0171  
Fax: (81) 3 5437-0755 sales@tuttle.co.jp  
[www.tuttle.co.jp](http://www.tuttle.co.jp)

**Asia Pacific**

Berkeley Books Pte. Ltd.  
61 Tai Seng Avenue  
#02-12 Singapore 534167  
Tel: (65) 6280-1330  
Fax: (65) 6280-6290  
inquiries@periplus.com.sg  
[www.periplus.com](http://www.periplus.com)

14 13 12 11  
10 9 8 7 6 5

Printed in Singapore

TUTTLE PUBLISHING® is a registered trademark of Tuttle Publishing, a division of Periplus Editions (HK) Ltd.

# Contents

## UNIT 1: What's your name?

### FUNCTION

- identifying people by name
- talking about ownership

### GRAMMAR

- possessive adjectives
- negation
- simple present

### VOCABULARY

- common objects
- family relationships

## UNIT 2: That'd be great!

### FUNCTION

- giving, accepting and declining invitations

### GRAMMAR

- personal pronouns
- imperatives
- present continuous

### VOCABULARY

- places to visit
- events

## UNIT 3: I'd like you to meet my accountant.

### FUNCTION

- introducing people

### GRAMMAR

- demonstratives

### VOCABULARY

- jobs
- social relationships

## UNIT 4: It's a beautiful day, isn't it?

### FUNCTION

- starting conversations

### GRAMMAR

- question tags • possessive pronouns

### VOCABULARY

- common adjectives
- common adverbs

## UNIT 5: Revision and extension

## UNIT 6: Would you like something to drink?

### FUNCTION

- making, accepting and declining offers

### GRAMMAR

- count/uncount
- nouns
- open questions

### VOCABULARY

- food and drink
- numbers 1-10

## UNIT 7: He's a tour guide.

### FUNCTION

- talking about occupations
- asking for clarification

### GRAMMAR

- simple past

### VOCABULARY

- occupations

## UNIT 8: I'm going to New York.

### FUNCTION

- asking about price
- talking about travel

### GRAMMAR

- present perfect
- duration

### VOCABULARY

- days and months
- money
- numbers 11-20
- transport

## UNIT 9: This one is better.

### FUNCTION

- asking for and giving opinions
- agreeing and disagreeing

### GRAMMAR

- comparatives and superlatives

### VOCABULARY

- food

## UNIT 10: Revision and extension

## UNIT 11: What's the matter?

### FUNCTION

- greetings and farewells
- talking about health

### GRAMMAR

- obligation

### VOCABULARY

- parts of the body
- common ailments

## UNIT 12: I live in the big house.

### FUNCTION

- talking about addresses and locations

### GRAMMAR

- future with will
- spatial prepositions

### VOCABULARY

- locators
- numbers over 20

## UNIT 13: How much is this purse?

### FUNCTION

- buying goods and services
- inquiring about health

### GRAMMAR

- some/any
- necessity

### VOCABULARY

- common containers
- musical instruments
- rooms

## UNIT 14: It's the second street on the left.

### FUNCTION

- asking for and giving directions

### GRAMMAR

- open questions
- directional prepositions

### VOCABULARY

- common institutions
- colors
- ordinal numbers

## UNIT 15: Revision and extension

## UNIT 16: **She bought a cake.**

### FUNCTION

- talking about the past

### GRAMMAR

- simple past
- regular and irregular verbs
- present continuous

### VOCABULARY

- activities and processes

## UNIT 17: **They're working in the garden.**

### FUNCTION

- using the telephone

### GRAMMAR

- gerunds
- present and past continuous
- before/after

### VOCABULARY

- telephone language

## UNIT 18: **What's the time?**

### FUNCTION

- talking about time
- making appointments

### GRAMMAR

- timetable future

### VOCABULARY

- times
- emotions

## UNIT 19: **You're not allowed to park here.**

### FUNCTION

- using public transport
- asking for, giving and refusing permission

### GRAMMAR

- prohibition
- quantifiers

### VOCABULARY

- transport
- time measurements

## UNIT 20: **Revision and extension**

## Preface

In an increasingly international world, being able to communicate in English is nowadays a necessity in social, professional and business life. Competence in English creates an increasing range of business, travel and leisure opportunities, opening doors to international communication.

*English Made Easy* is a breakthrough in English language learning—imaginatively exploiting how pictures and text can work together to create understanding and help learners learn more productively.

*English Made Easy* gives learners easy access to the vocabulary, grammar and functions of English as it is actually used in a comprehensive range of social situations. Self-guided students and classroom learners alike will be delighted by the way they are helped to progress easily from one unit to the next, using the combinations of pictures and text to discover for themselves how English works.

The *English Made Easy* method is based on a thorough understanding of language structure and how language is successfully learned. The authors are experienced English language teachers with strong backgrounds in language analysis and language learning. The *English Made Easy* team is confident that the books represent a significant development in English language learning.

—Professor Christopher N. Candlin

## Using this book

This book is easy to use. You will learn how to speak English by looking at the pictures and words on each page. The pictures explain the words.

The table of contents tells you what you will learn in each of the twenty units. You can use this table to look up any particular points you want to learn or practice.

The twenty units are arranged in groups of five. The first four units present language and give you opportunities to practice as you learn. The first page of each unit has a list of all the words and phrases you will learn in that unit, together with a pronunciation guide. At the end of each unit there is an interesting story which uses the language you have just learned.

The fifth unit in each group gives you the opportunity to revise the language in the first four units and to use it in different situations. The exercises are easy to understand and there is an answer key at the end of the unit.

At the end of the book there is an index which contains all the words and phrases in the book. It is not a dictionary. It refers you to the unit in which that language first appears so that you can “discover” the meaning of the word by seeing it in context.



## UNIT 1: What's your name?

a [ei, ə]

the [ðə]

book [buk]

camera [kæm'ərə]

car [kɑ:r]

house [haus]

key [ki:]

laptop [læp'ta:p]

mobile phone [moub'əl foun]

pen [pen]

purse [pɜ:rs]

wallet [wa:l'it]

watch [wa:tʃ]

whose [hu:z]

her [hə:r]

his [hiz]

my [maɪ]

our [au'ə:r]

their [ðe:r]

your [ju:r]

My name's ... [maɪ neɪmz]

What's your name? [wɒts ju:r neɪm]

yes [jes]

no [nou]

I don't know. [aɪ daʊnt nou]

family [fæm'li:]

husband [hʌz'bænd]

wife [waɪf]

father [fa:'ðə:r]

mother [mʌð'ə:r]

son [sʌn]

daughter [dɔ:t'ə:r]

brother [brʌð'ə:r]

sister [sɪs'tə:r]

name [neɪm]

is [ɪz]

isn't [iz'ənt]

it [it]

this [ðis]

what [ðis iz]

this is [ðis iz]

it's [its]

Excuse me. [ɪksku:z' mi:]

Thank you. [θæŋk ju:]

 what is = what's

 my name is = my name's

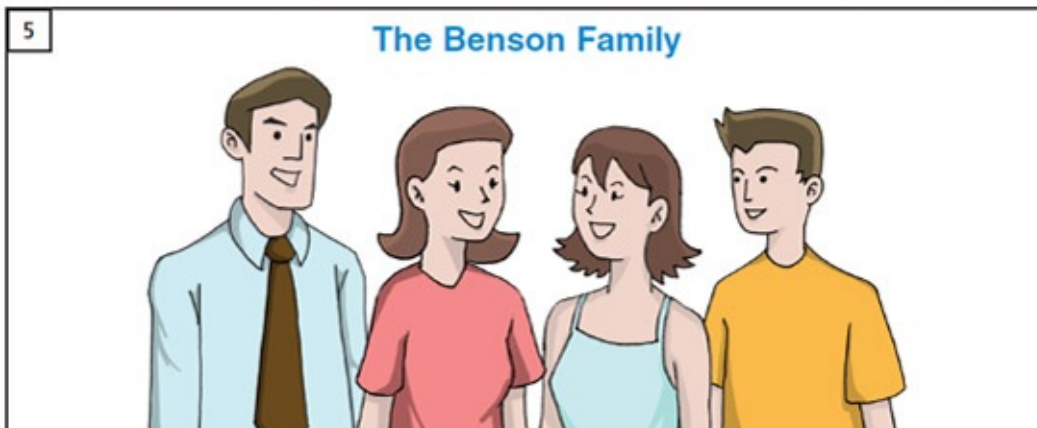
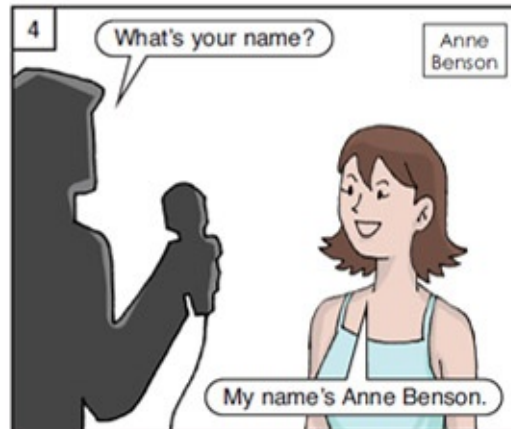
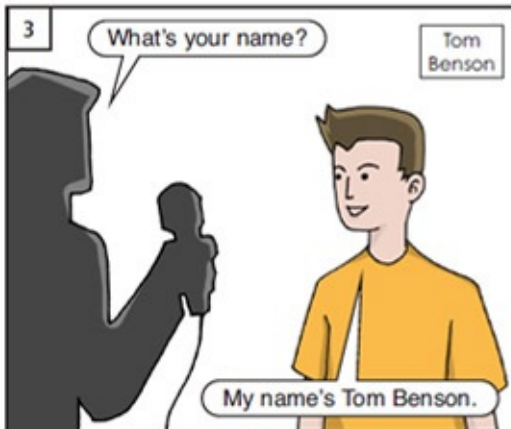
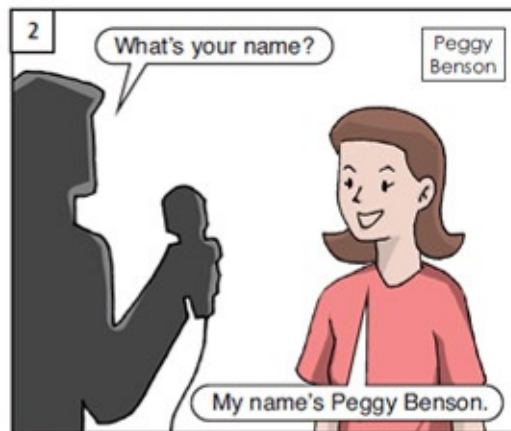
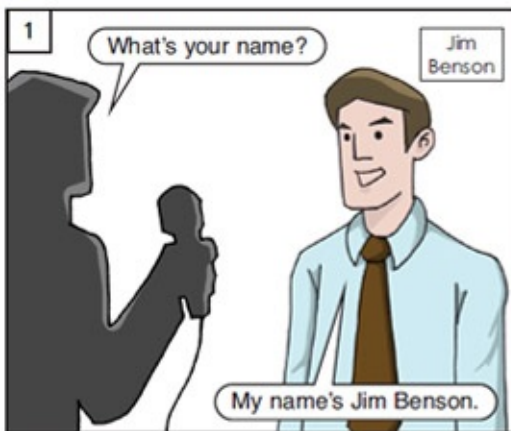

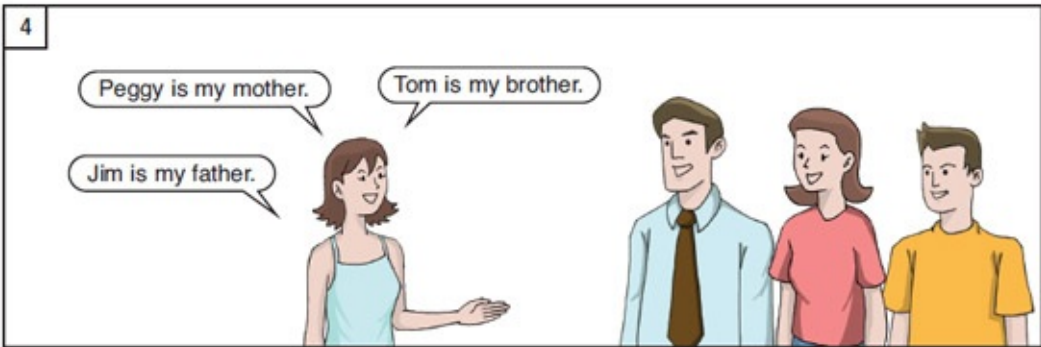
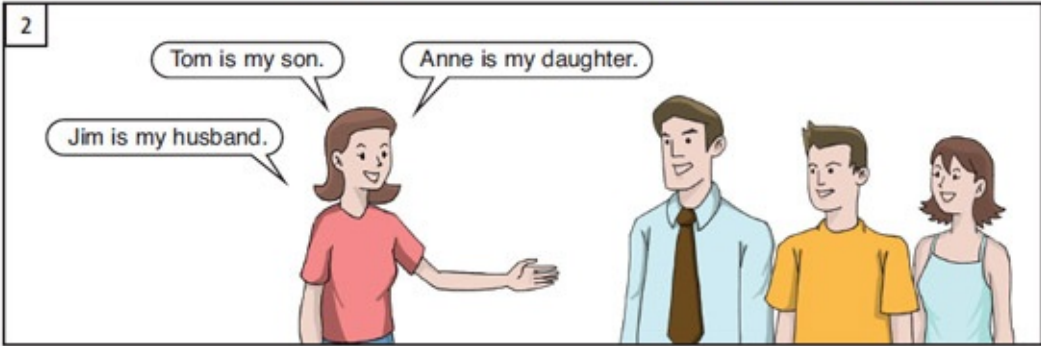
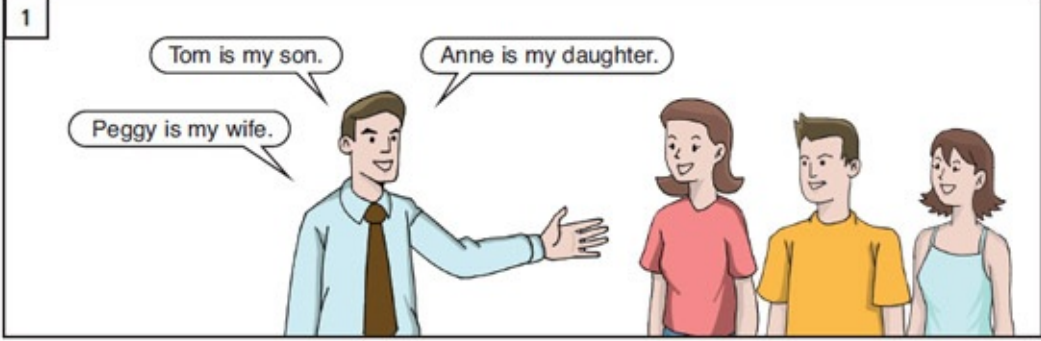

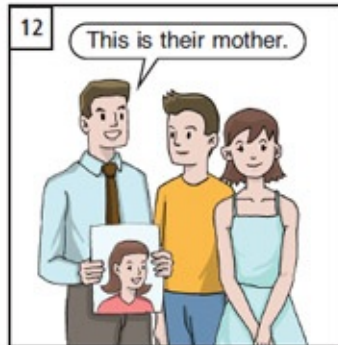
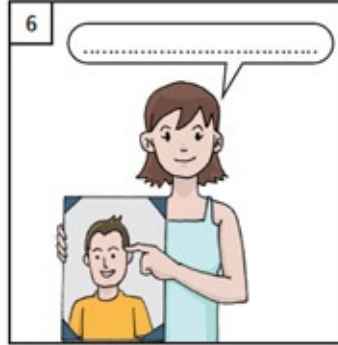
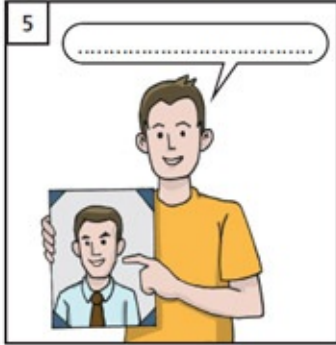
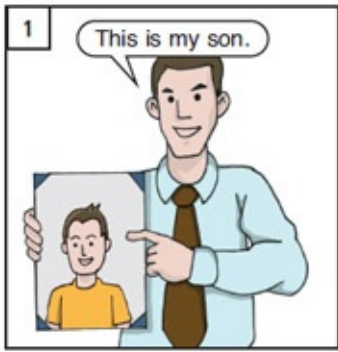

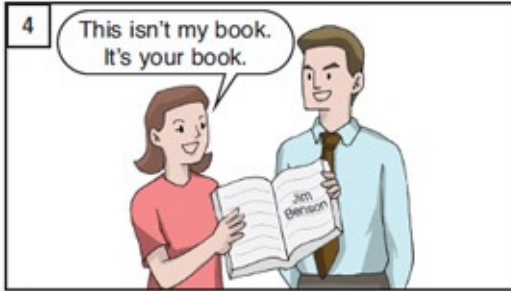
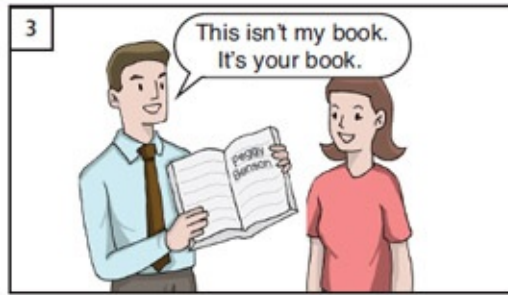
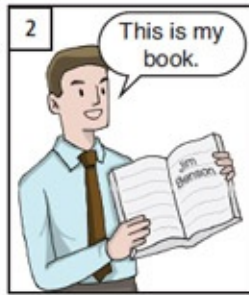
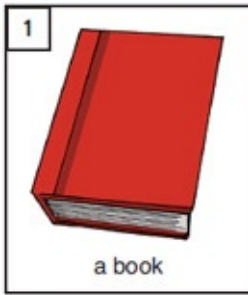

 it is = it's

 is not = isn't



 do not = don't

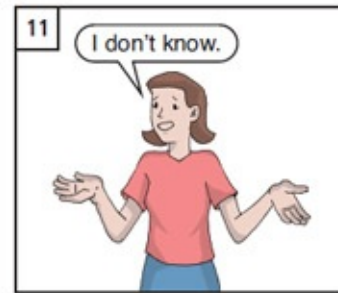
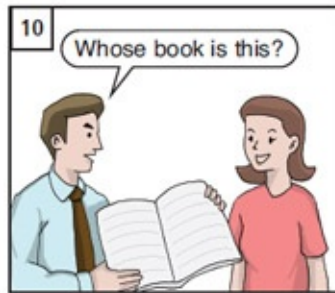
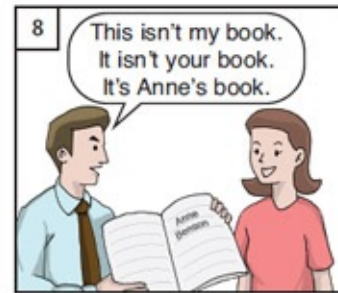
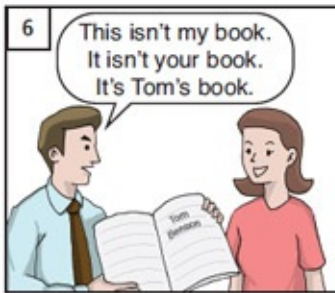

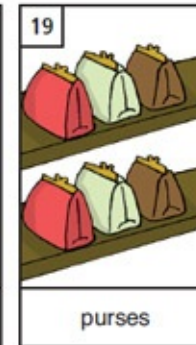
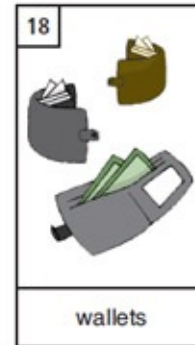
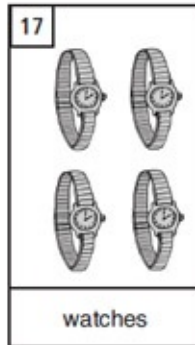
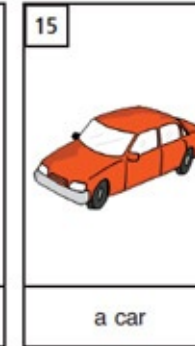
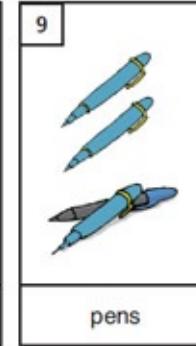
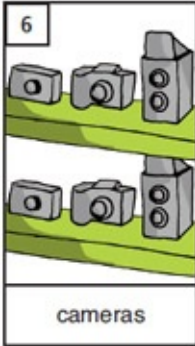
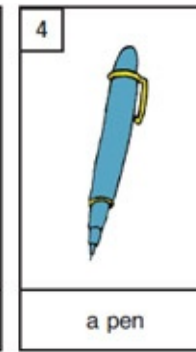



# The Bensons

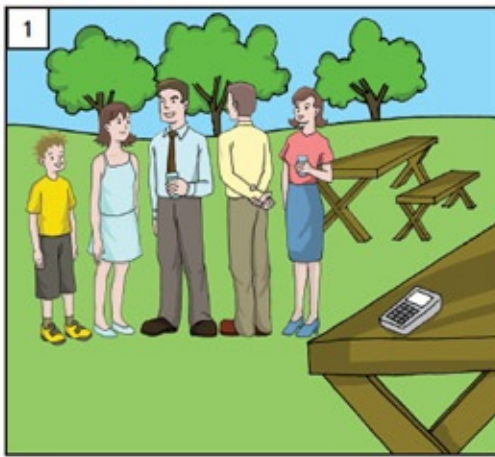



## UNIT 2: That'd be great!

art gallery [a:rt gæl'ə:ri:]

beach [bi:tʃ]

concert [kɑ:n'sə:rt]

dinner [din'ə:r]

lunch [lʌntʃ]

meeting [mi:'tiŋ]

movies [mu:'vi:z]

picnic [pik'nik]

party [pɑ:r'ti:]

restaurant [res'tɔ:rənt]

theater [θi:'ə:tə:r]

market [mɑ:r'kit]

How about...? [hau əbaut']

let's [lets]

Would you like to come to...? [wud ju: laik tu: kʌm tu:]

I'd love to but I can't. [aid lʌv tu: bʌt ai kænt]

I'm afraid I can't. [aim əfreid' ai kænt]

Sorry, I can't. [sɑ:r'i: ai kænt]

door [en'tɔ:r]

enter [en'tɔ:r]

exit [eg'zit]

am [æm]

are [ɑ:r]

who [hu:]

but [bʌt]

bring [brɪŋ]

bringing [brɪŋ'ɪŋ]

can [kæn]

come [kʌm]

coming [kʌm'ɪŋ]

go [ɡoʊ]

going [ɡoʊ'ɪŋ]

take [teɪk]

taking [teɪk'ɪŋ]

know [noʊ]

Sure. [ʃu:r]

I'd love to. [aɪd lʌv tu:]

That'd be great. [ðætə'd bi:greɪt]

OK. [oʊkeɪ ]

in [ɪn]

out [aʊt]

to [tu:]

I [aɪ]

you [ju:]

he [hi:]

she [ʃi:]

we [wi:]

they [ðei]

me [mi:]

you [ju:]

him [hɪm]

her [hər]

us [ʌs]

them [ðem]

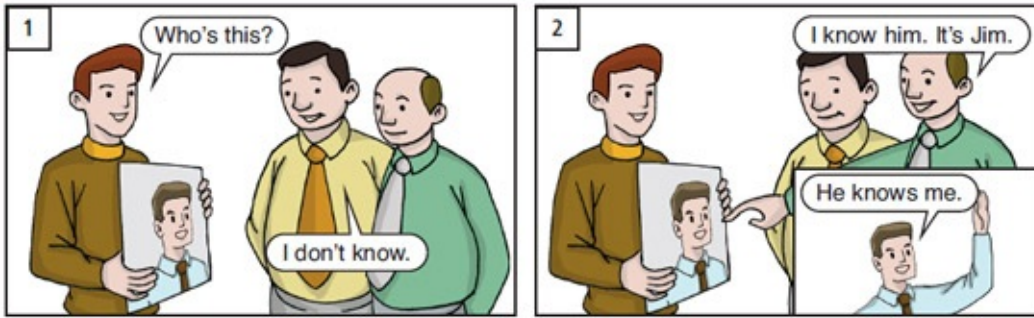

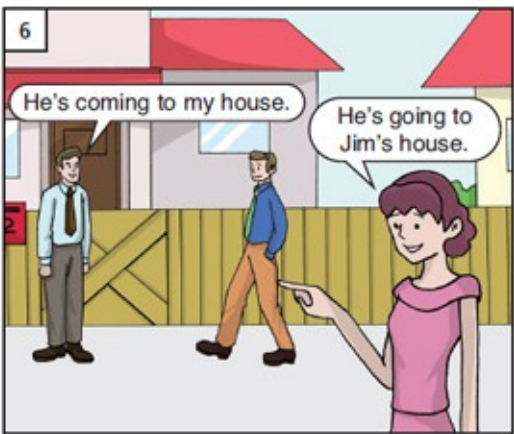
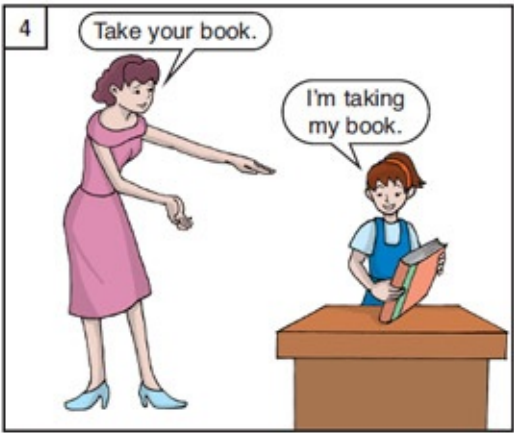
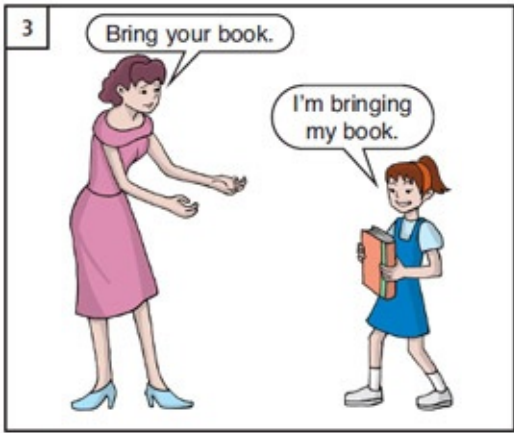
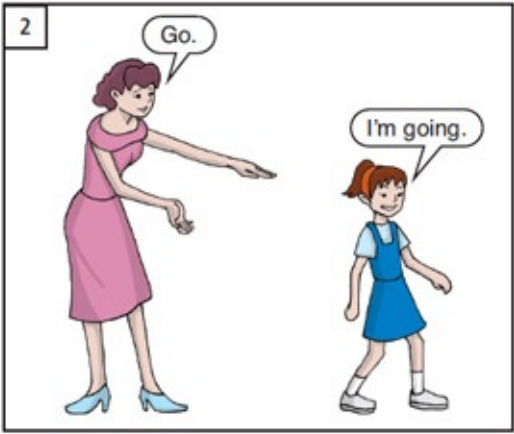
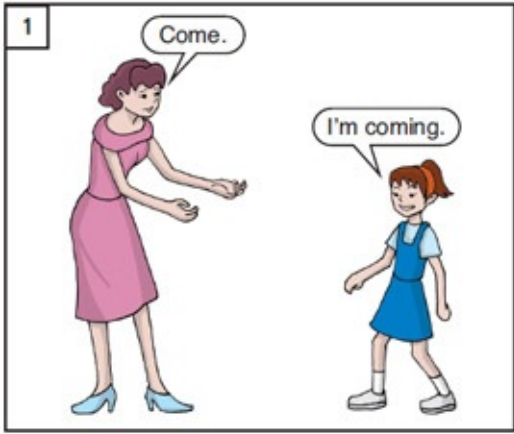

 I am = I'm

 he is = he's

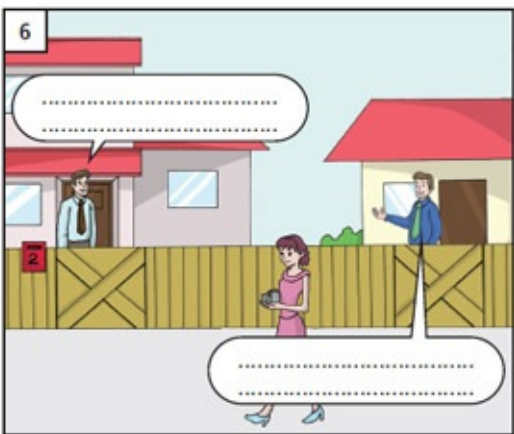
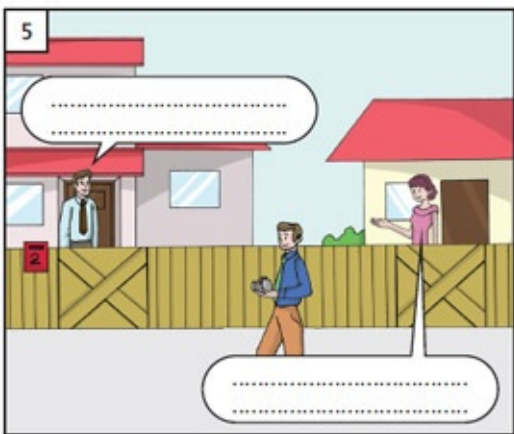
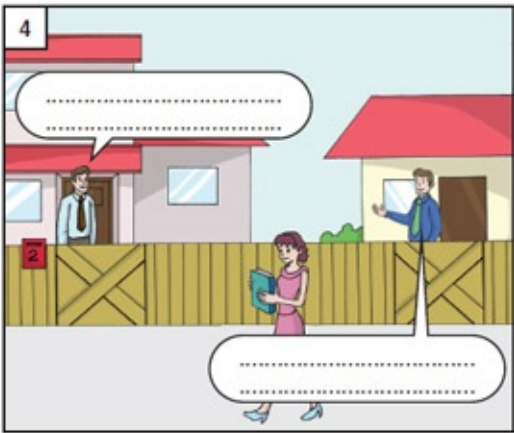
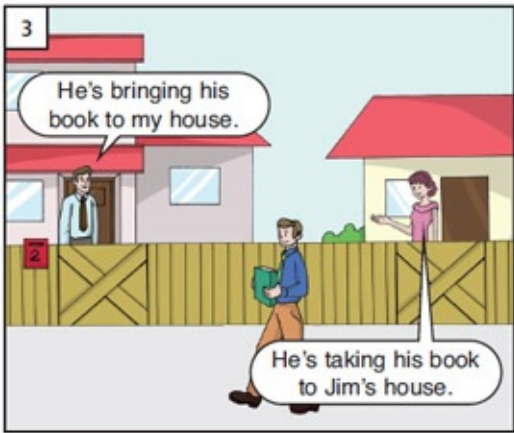
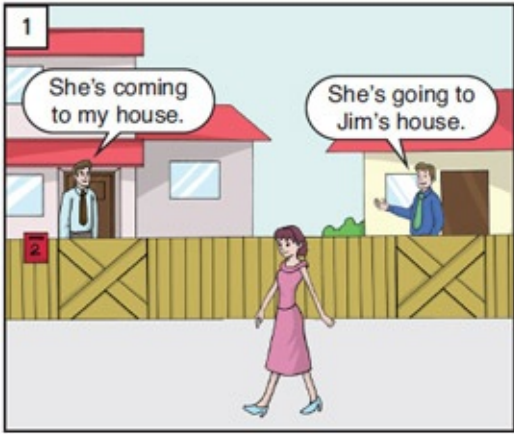



 that would = that'd

 I would = I'd

 cannot = can't

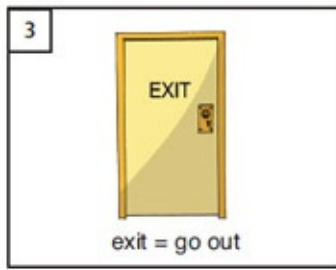
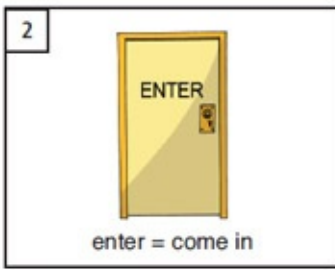
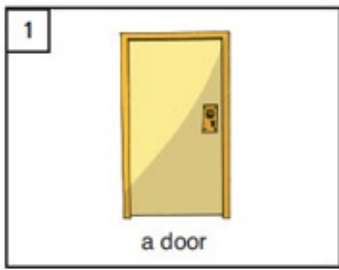

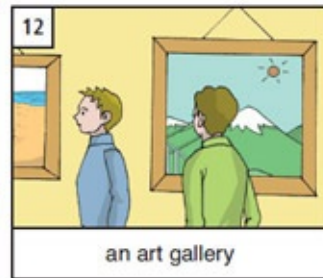
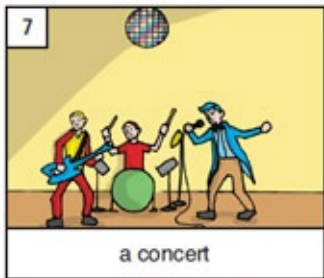
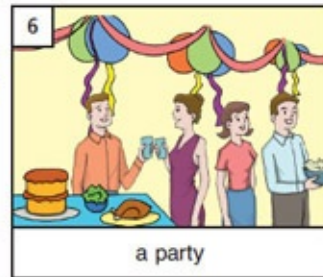
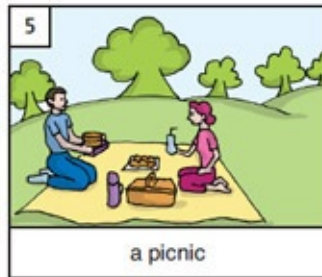
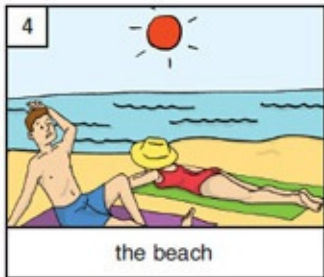
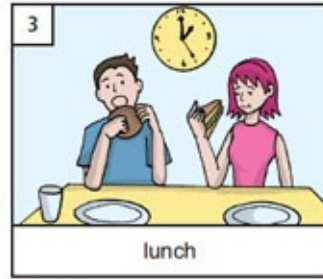
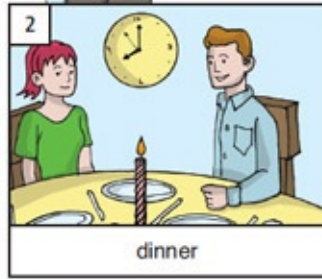
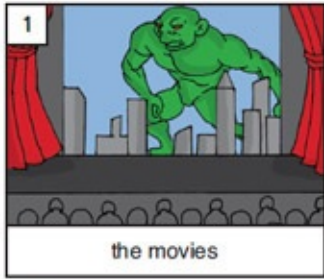

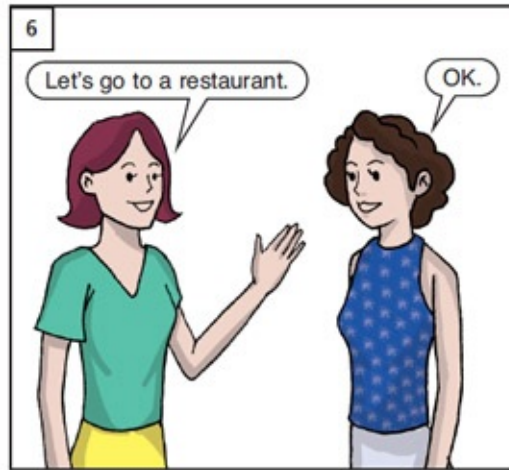
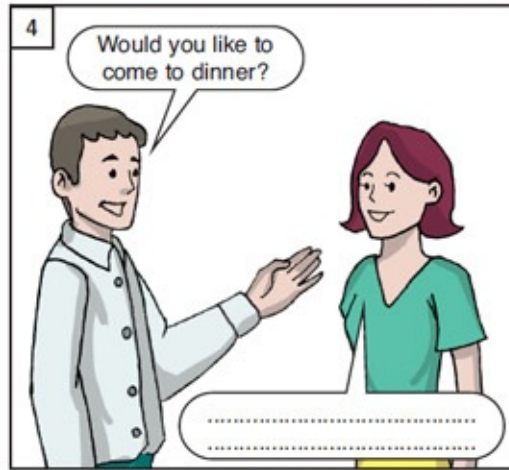
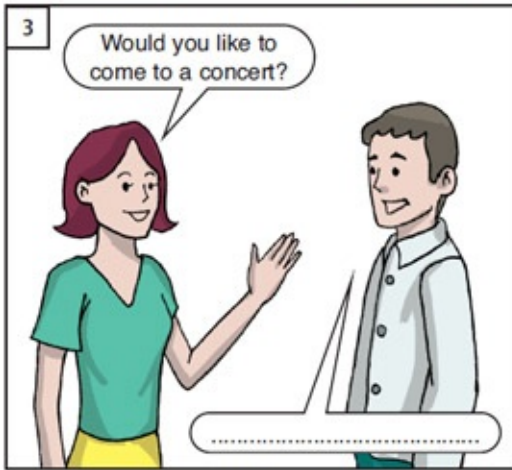
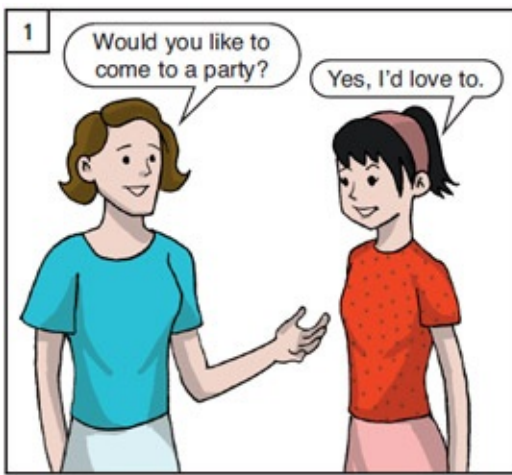





he would = he'd



## UNIT 3: I'd like you to meet my accountant.

**meet** [mi:t]

**met** [met]

**Have you met...?** [hæv ju: met]

**I'd like you to meet...** [aid laik ju: tu: mi:t]

**Hi.** []

**No, I haven't.** [nou ai hæv'ənt]

**Good to meet you.** [ud tu: mi:t ju:]

**here** [hi:r]

**that** [ðæt]

**there** [ðe:r]

**these** [ði:z]

**those** [ðouz]

**where** [we:r]

**accountant** [əkaun'tənt]

**colleague** [ka:l'i:g]

**friend** [frend]

**teacher** [ti:tʃə:r]

**manager** [mæn'idʒə:r]

**neighbor** [neib'ə:r]

**secretary** [sek'riteri:]

**looks like** [luks laik]

**I'd like** [aid laik]



where is = where's



that is = that's

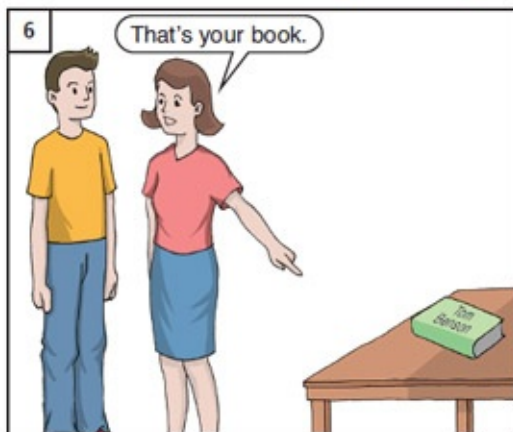
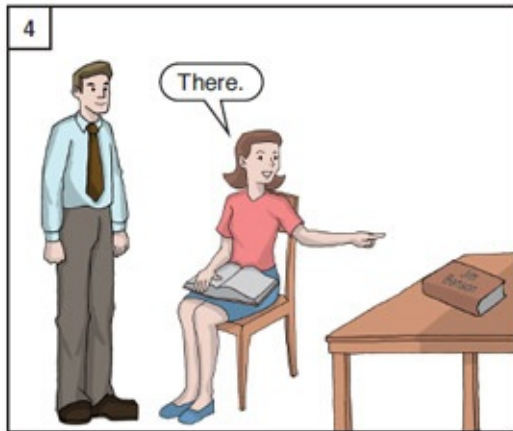
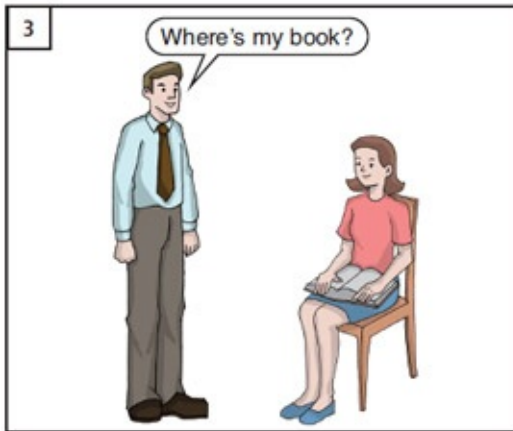
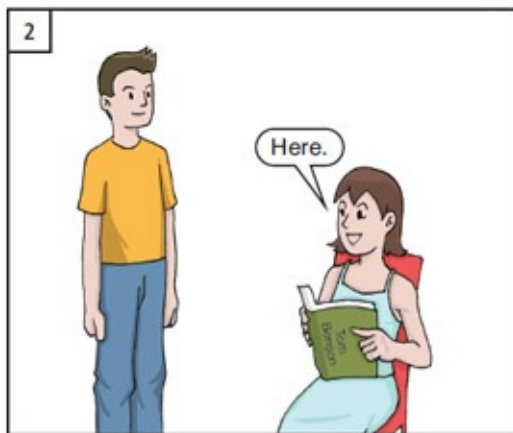



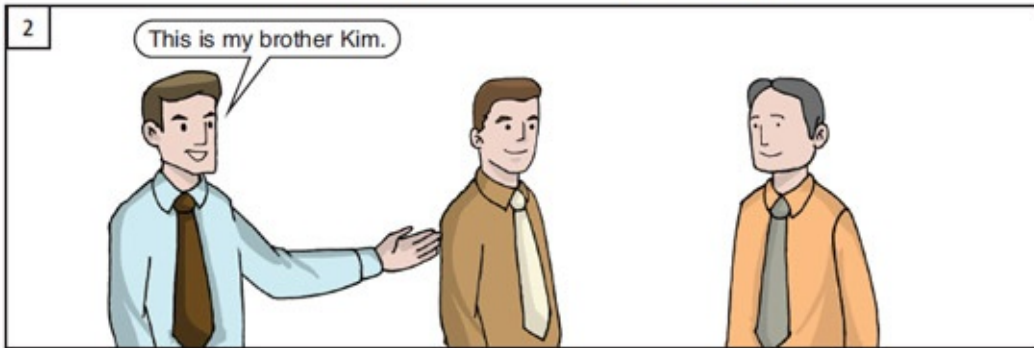
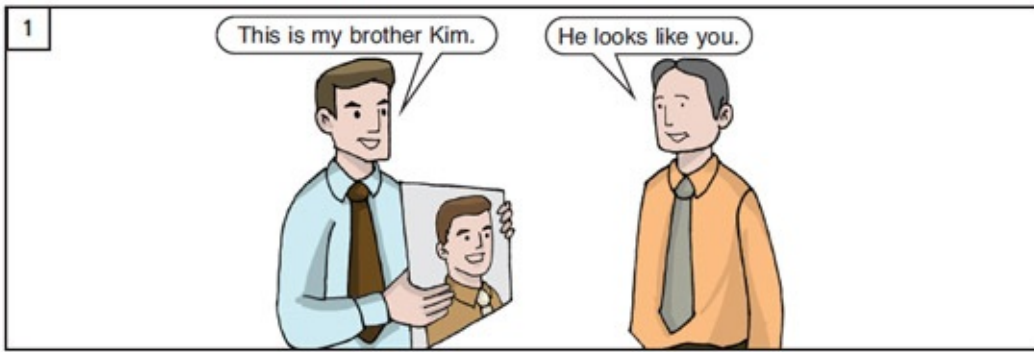

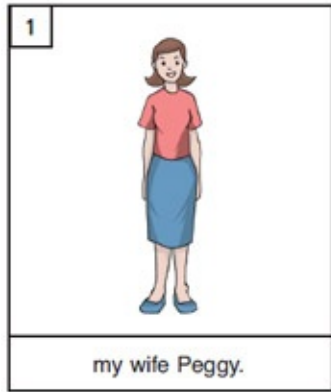

my wife Peggy.

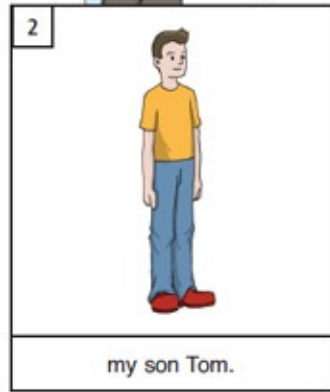

my son Tom.

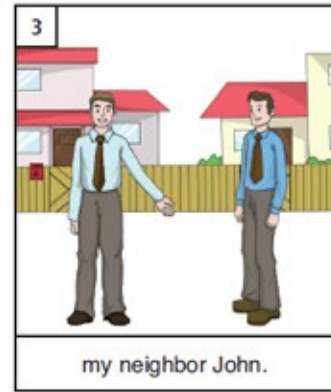

my neighbor John.



my secretary Janice.



my accountant Henry.



my manager Mr. Lee.

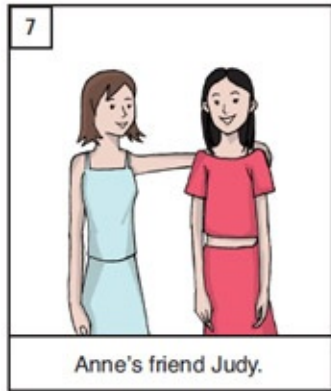

Anne's friend Judy.



Tom's teacher Mrs Cooper.



my colleague David.

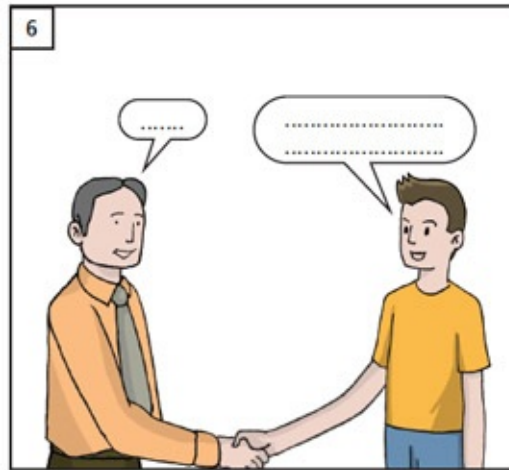
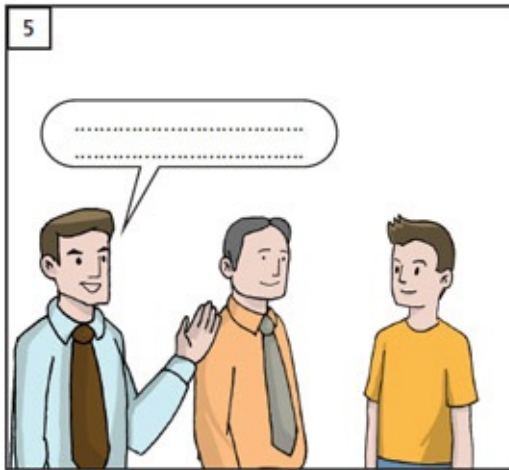



have not = haven't

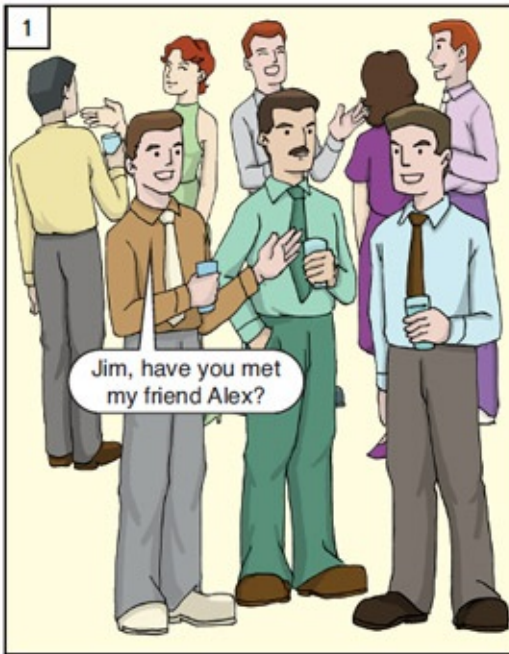



# The Bensons

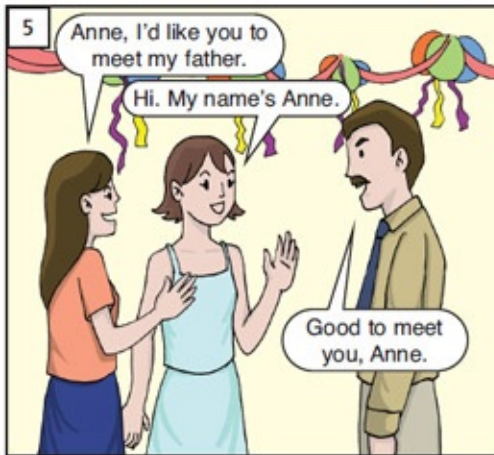
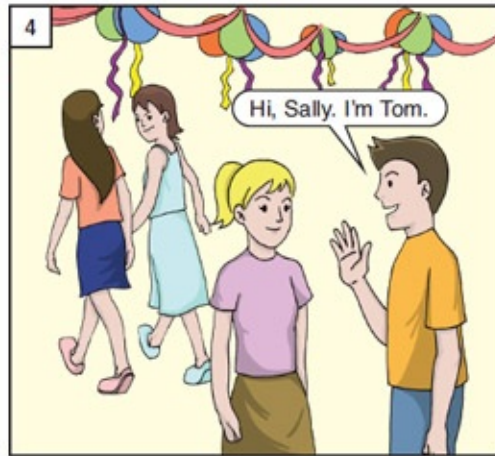

## UNIT 4: It's a beautiful day, isn't it?

**not** [nɑ:t]

**aren't** [ɑ:nt]

**doesn't** [dʌz'nt]

**don't** [dɒnt]

**isn't** [iz'ənt]

**does** [iz'ənt]

**do** [du:]

**beautiful** [bju:'tɪfəl]

**cold** [kəʊld]

**cute** [kjʊ:t]

**fast** [fæst]

**good** [ɡʊd]

**great** [ɡreɪt]

**hot** [hɒt]

**wet** [wet]

**well** [wel]

**lovely** [lʌv'li:]

**fit** [fɪt]

**looks good** [luks ɡʊd]

**runs** [rʌnz]

**play** [pleɪ]

**work** [wɜ:k]

**sit** [sɪt]

**baby** [beɪ 'bi:]

**day** [deɪ]

**shoes** [ʃu:z]

**view** [vju:]

**plane** [pleɪn]

**seat** [si:t]

**mine** [maɪn]

**yours** [jʊ: rz]

**It's all right.** [ɪts ə:l raɪt]

 you are = you're

 are not = aren't





they are = they're

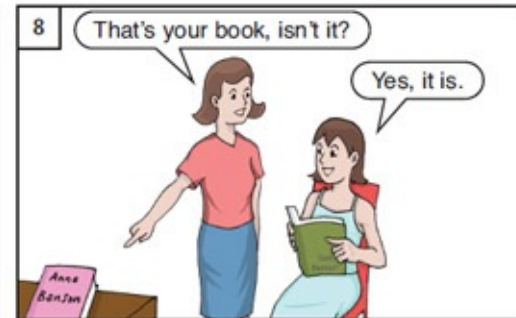
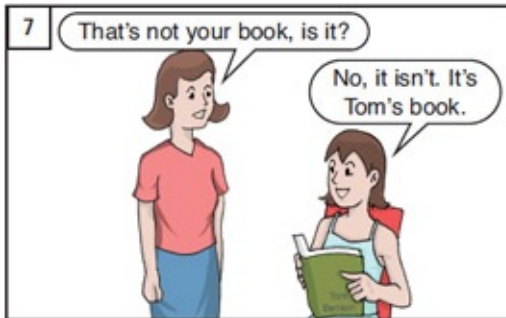
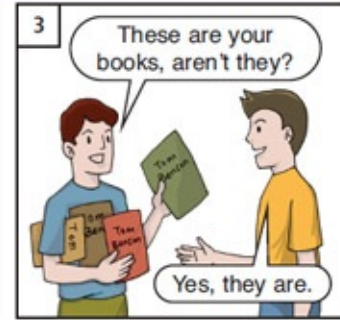
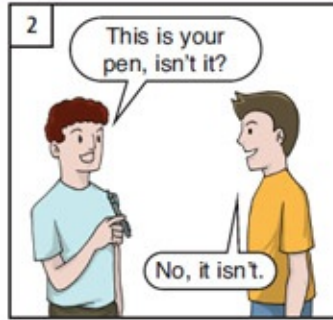
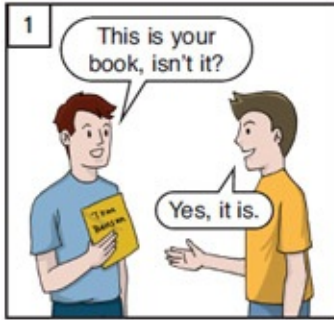

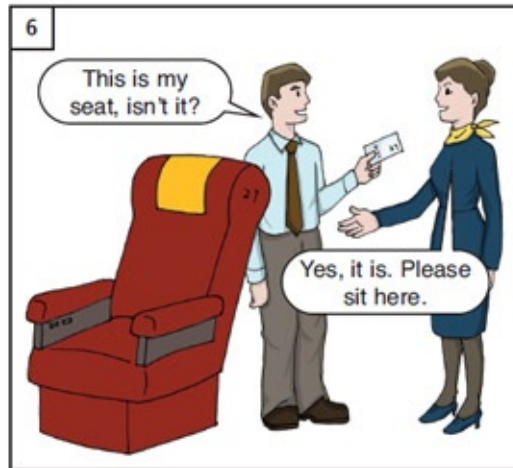
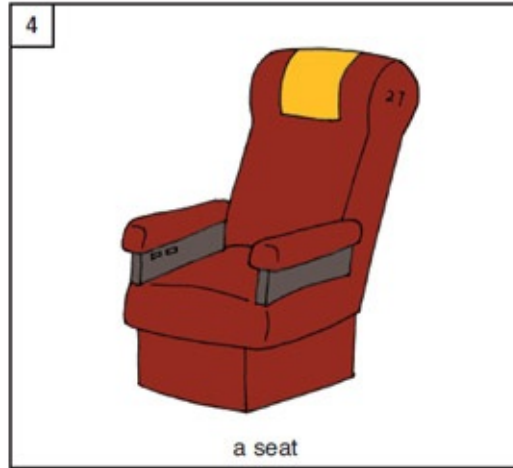
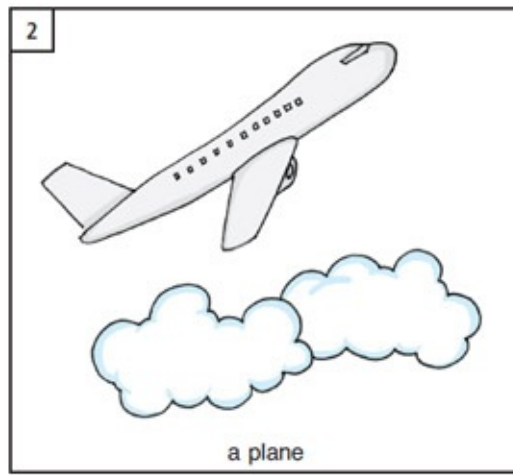

It's...

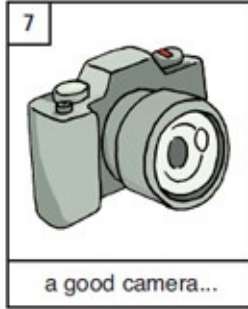
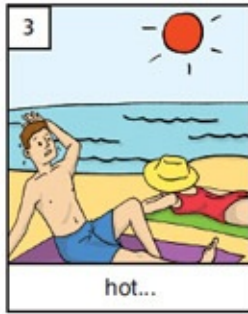

isn't it?

Yes, it is.





does not = doesn't.

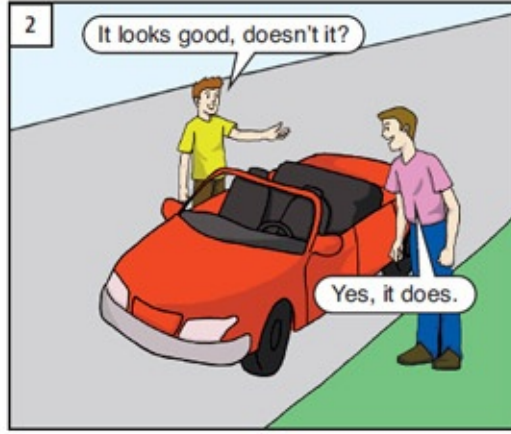
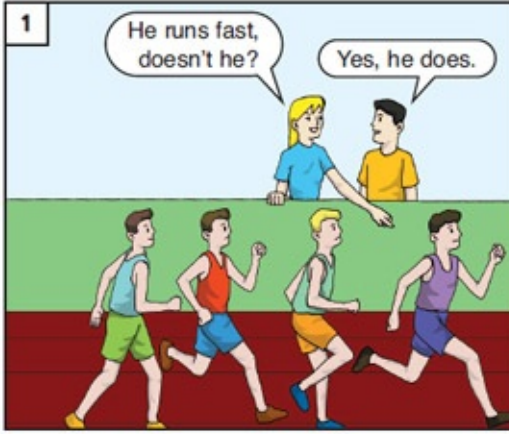

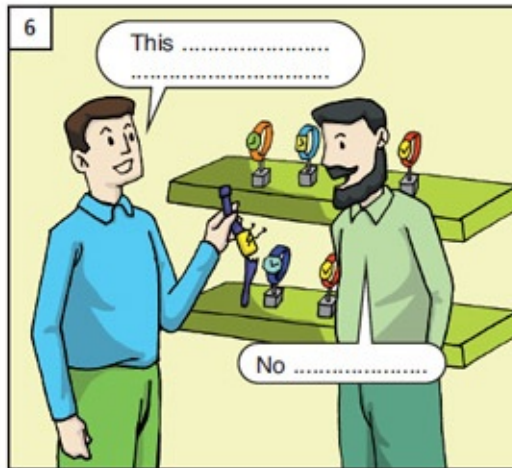
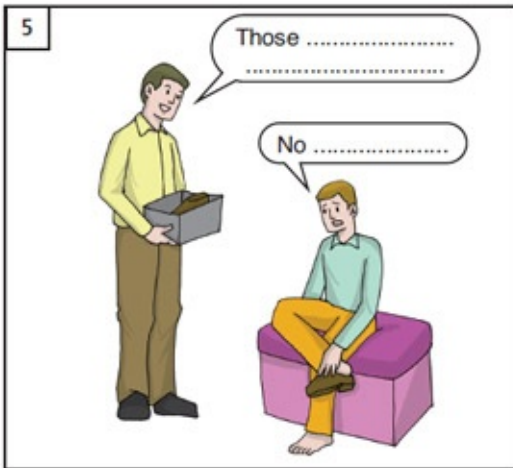
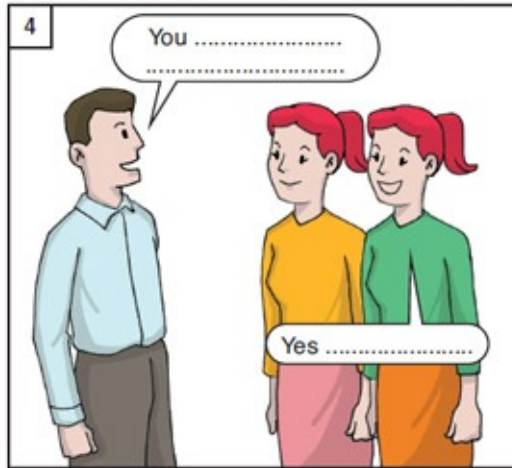
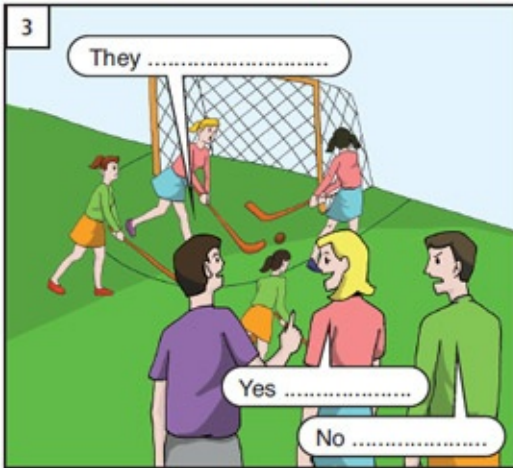
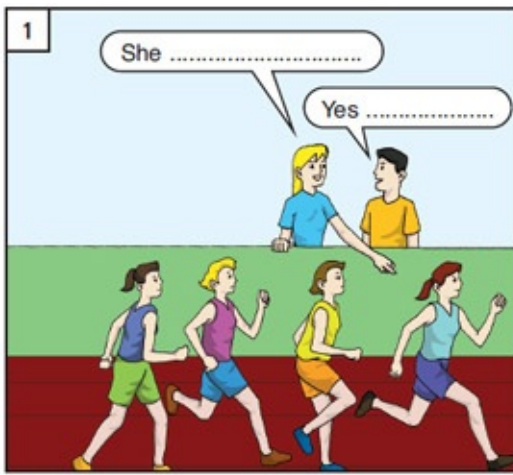

















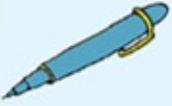



# The Bensons



# UNIT 5: Revision and extension

1  book .....	2  .....	3  .....	4  .....
5  .....	6  .....	7  .....	8  .....
9  .....	10  .....	11  .....	12  .....
13  .....	14  .....	15  .....	
16  .....	17  .....	18  .....	
19  .....	20  .....		



**A**

1. What's your name?
2. Whose book is this?
3. Would you like to come to my party?
4. Thank you.
5. Where's my book?
6. This is my brother Kim.

- a. That's OK.
- b. Good to meet you.
- c. Tom.
- d. It's her book.
- e. Here.
- f. Yes, I'd love to.

**B**

1. Are you Jim Benson?

- a. Yes, he is.

2. Is your name Jim Benson?
3. These are your books, aren't they?
4. He is your father, isn't he?
5. She is your sister, isn't she?

- b. Yes, she is.
- c. Yes, it is.
- d. Yes, they are.
- e. Yes, I am.

**C**

1. He runs fast, doesn't he?
2. This camera doesn't work, does it?
3. These shoes don't fit, do they?
4. You look like your brother, don't you?

- a. Yes, he does.
- b. No, they don't.
- c. Yes, I do.
- d. No, it doesn't.



yours

your

it's

mine

it isn't

Whose

this

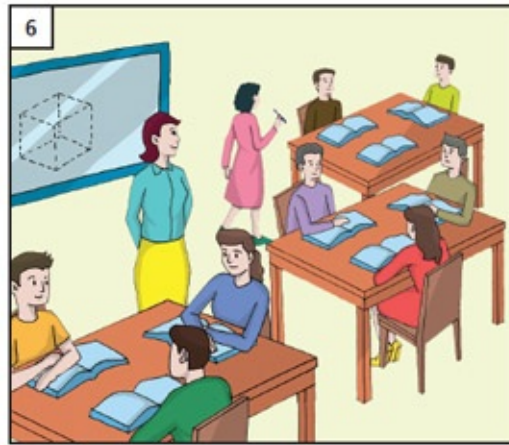
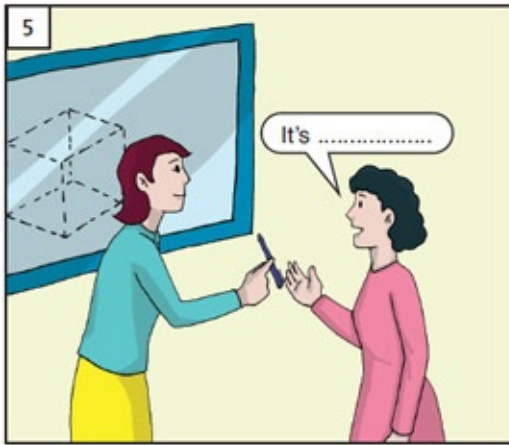
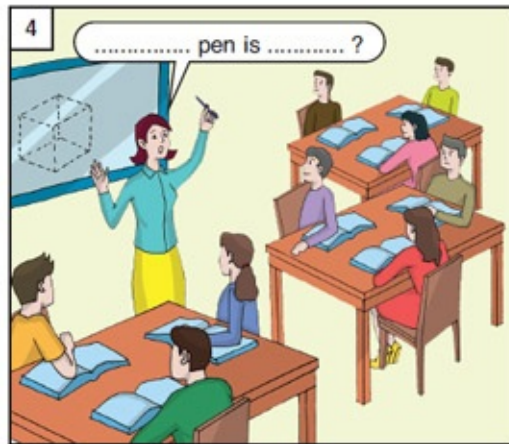

it is

your

like to

meet

My

isn't it

1



2



3



4



Yes

about

can't

I am

Good

haven't





- > restaurant go a Let's to
- > OK

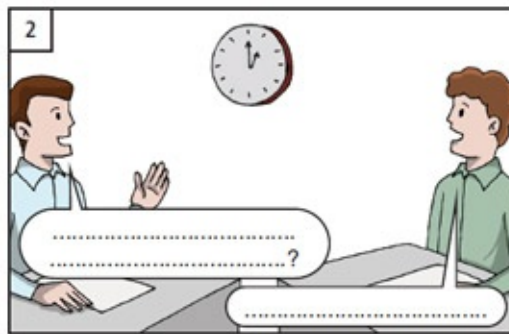

- > come like to you Would to lunch
- > can't afraid I'm I Sorry

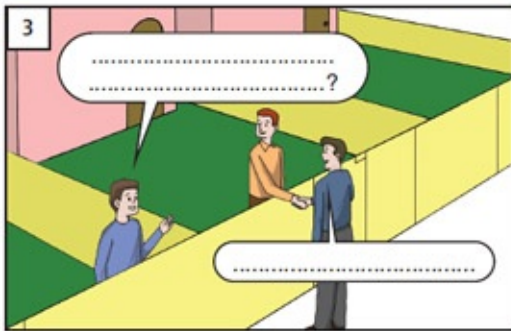

- > met neighbor you my Have
- > haven't No I



- > meet to Jane like I'd you
- > meet you to Good



- > movie to going about How a
- > great be That'd



- > going You're to the meeting aren't you
- > I'm No not



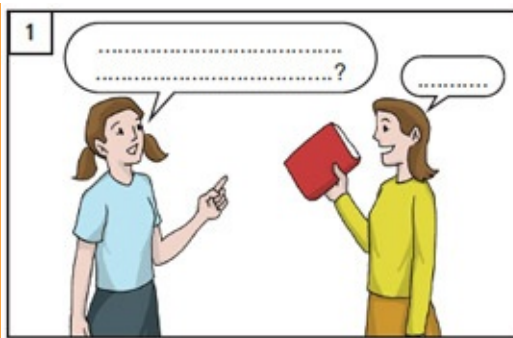

- > book It's interesting an isn't it
- > it Yes is

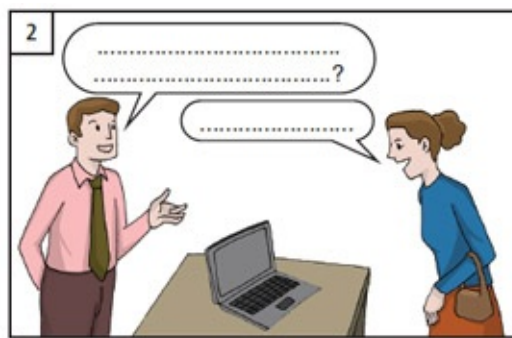

- > good This looks laptop doesn't it
- > does Yes it



- > pen my That's isn't it
- > isn't No it



- > are keys yours These aren't they
- > Yes are they



- > here work You don't you
- > No I don't



- > concerts like You don't you
- > do I Yes

## UNIT 5: Answers

Unit 5, page 38

1. book
2. camera
3. car
4. family

5. watch
  6. house
  7. laptop
  8. mobile phone
  9. pen
  10. purse
  11. beach
  12. key
  13. art gallery
  14. dinner
  15. market
  16. lunch
  17. meeting
  18. theater
  19. party
  20. restaurant
- 

Unit 5, page 39

21. accountant
22. colleague
23. friend
24. manager
25. neighbor
26. secretary
27. teacher
28. baby
29. name
30. plane
31. seat
32. cold
33. shoes
34. view
35. wet
36. hot
37. movies
38. door

- 39. wallet
  - 40. concert
- 

Unit 5, page 40

- A. 1c 2d 3f 4a 5e 6b B. 1e 2c 3d 4a 5b
  - c. 1a 2d 3b 4c
- 

Unit 5, page 41

- 1. this, isn't
  - 2. his
  - 3. Come
  - 4. isn't it
  - 5. mine
- 

Unit 5, page 42

- 1. your
  - 2. it's
  - 3. yours? it isn't
  - 4. Whose, this 5. mine
- 

Unit 5, page 43

- 1. isn't it, it is
  - 2. My, meet
  - 3. your
  - 4. like to
- 

Unit 5, page 44

- 2. I am
  - 3. haven't, Good 4. Yes 5. can't 6. about
- 

Unit 5, page 45

- 1. Let's go to a restaurant.
- OK.

**2. Would you like to come to lunch? Sorry, I'm afraid I can't.**

**3. Have you met my neighbor?**

**No, I haven't.**

**4. I'd like you to meet Jane.**

**Good to meet you.**

**5. How about going to a movie? That'd be great.**

**6. You're going to the meeting, aren't you? No, I'm not.**

---

**Unit 5, page 46**

**1. It's an interesting book, isn't it? Yes, it is.**

**2. This laptop looks good, doesn't it? Yes, it does.**

**3. That's my pen, isn't it?**

**No, it isn't.**

**4. These keys are yours, aren't they? Yes, they are.**

**5. You work here, don't you? No, I don't.**

**6. You like concerts, don't you? Yes, I do.**

## UNIT 6: Would you like something to drink?

**Would you like...?** [wʊd ju: laɪk]

**What would you like?** [wɔ:t wʊd ju: laɪk]

**No, thanks.** [nəʊ θæŋks]

**Yes, please.** [jes pli:z]

**...would be nice.** [wʊd bi: naɪs]

**cookie** [kʊk 'i:]

**chips** [tʃɪps]

**sausage** [sɔ: 'sɪdʒ]

**nuts** [nʌts]

**cake** [keɪk]

**sandwich** [sænd'wɪtʃ]

**burger** [bɜ:r'gɜ:r]

**How many... ?** [hou meni:]

**one** [wʌn]

**two** [tu:]

**three** [θri:]

**four** [fɔ:r]

**five** [faɪv]

**six** [sɪks]

**seven** [bɜ:r'gɜ:r]

**eight** [eɪt]

**nine** [naɪn]

**ten** [ten]

**something to eat** [sʌm'θɪŋ tu: i:t]

**piece of...** [pi:s ʌv]

**something to drink** [sʌm'θɪŋ tu: drɪŋk]

**cup of...** [kʌp ʌv]

**glass of...** [glæs ʌv]

**can of...** [kæn ʌv]

**bottle of...** [bɔ:t'əl ʌv]

**juice** [dʒu:s]

**milk** [mɪlk]

**water** [wɔ:'tɜ:r]

**tea** [ti:]

**coffee** [kɔ:f'i:]

**sugar** [ʃʊg'ɜ:r]

**apple** [æp'əl]

**banana** [bənæ'nə]

**peach** [pi:tʃ]

**orange** [ɔ:r'ɪndʒ]

plum [plʌm]

pear [peɪr]

bag [bæg]

child [tʃaɪld]

tablet [tæb'let]

ticket [tik'ət]

sock [sɔ:k]

a pair of [ə peɪr əv]

some [sʌm]

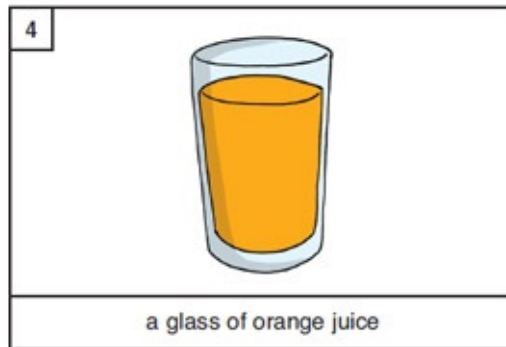
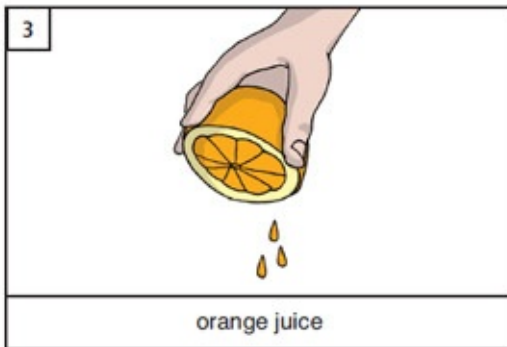
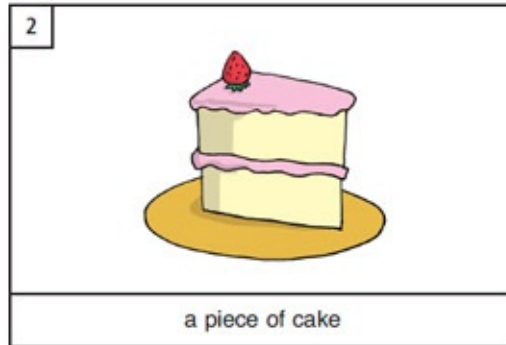
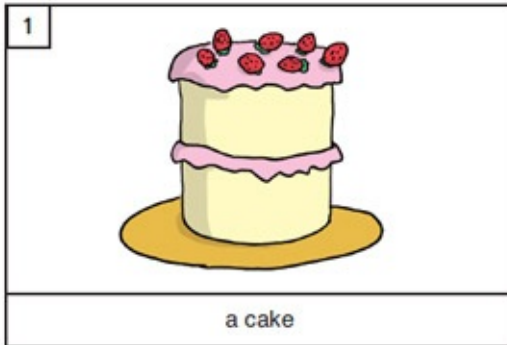

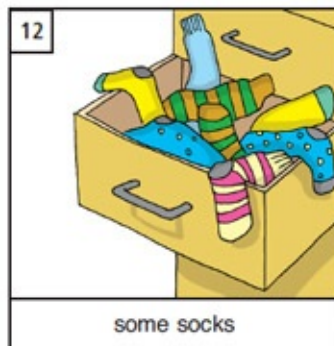
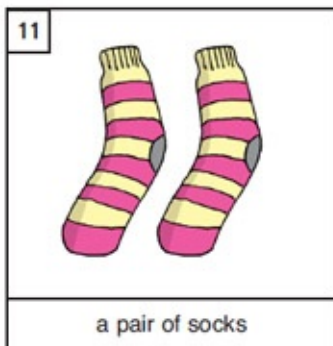
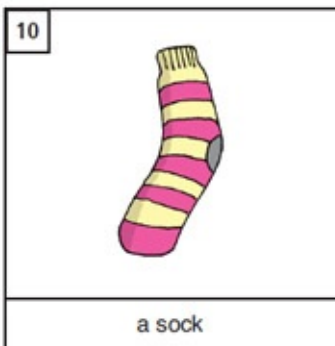
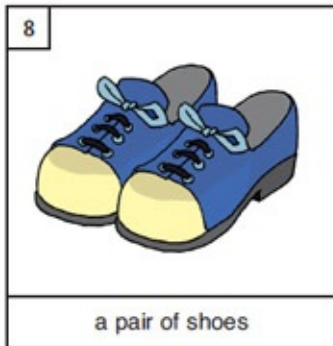
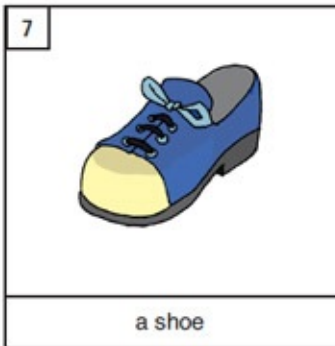
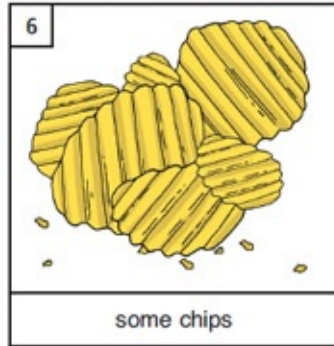
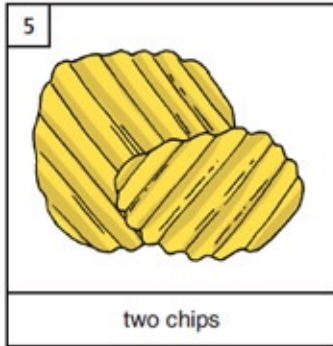
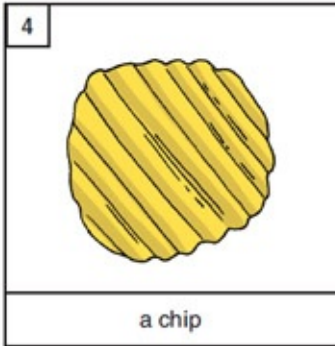
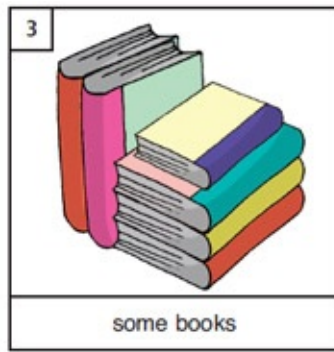
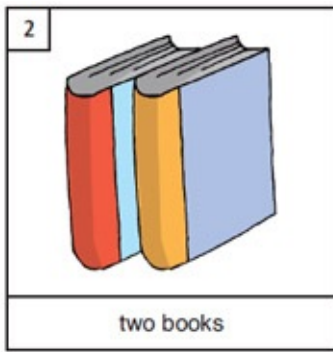
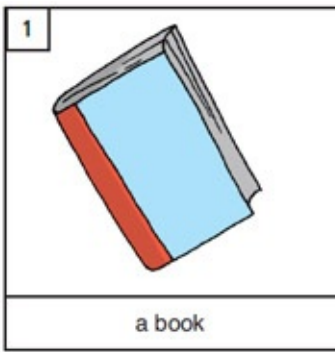



Would you like...?

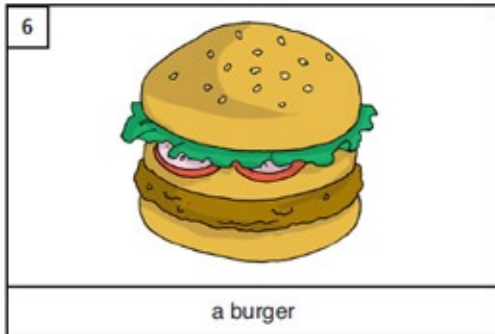
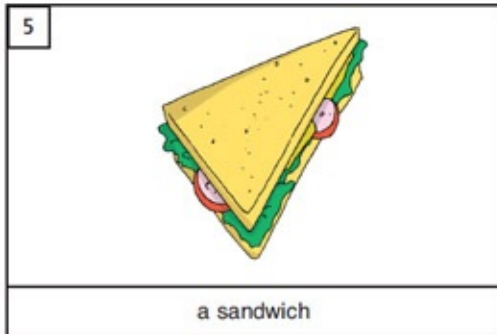
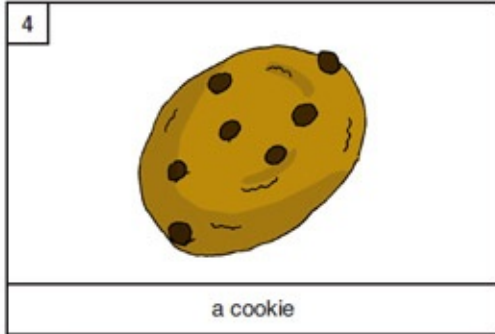
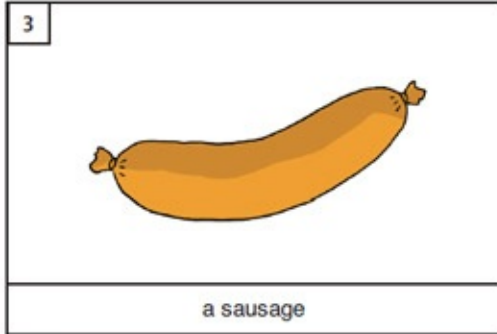
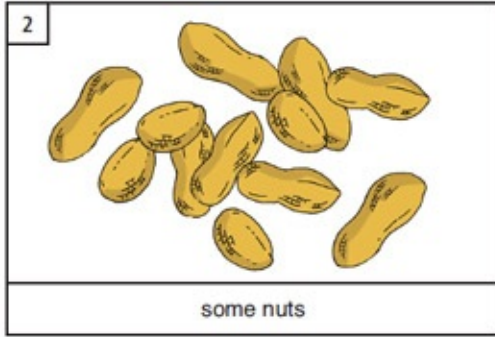
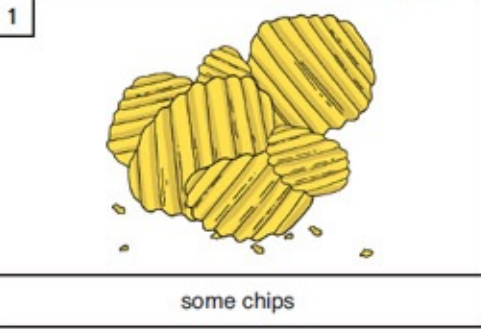

something to eat







Yes, please.

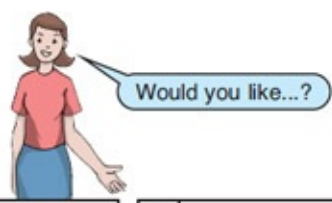

No, thanks.



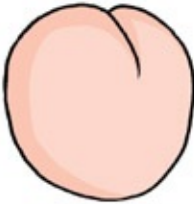
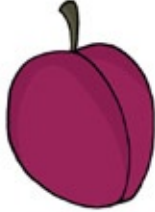

1  an apple	2  an orange
3  a banana	4  a pear
5  a peach	6  a plum

something to eat





Would you like...?

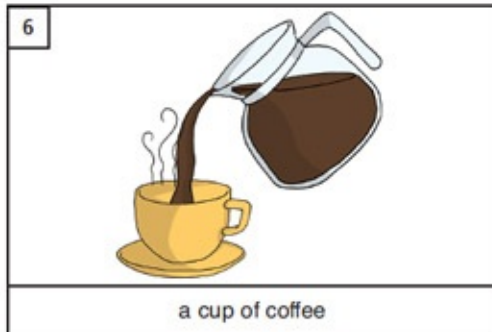
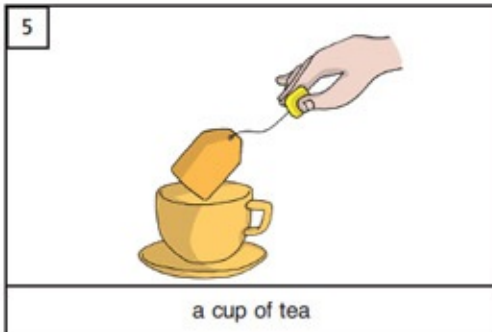
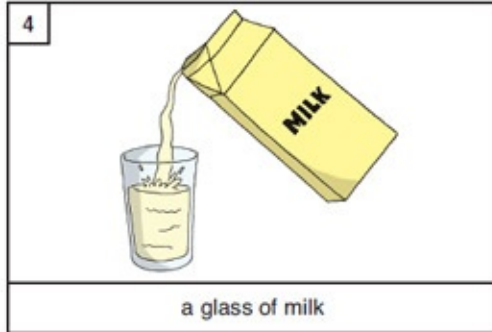
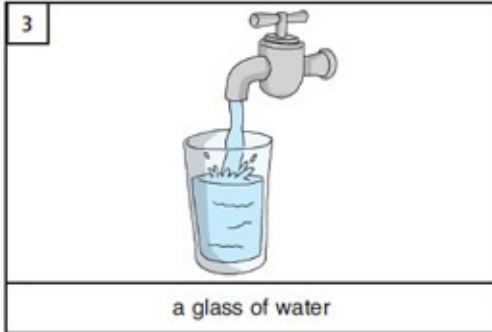
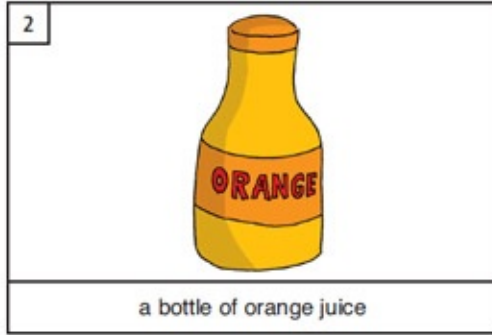
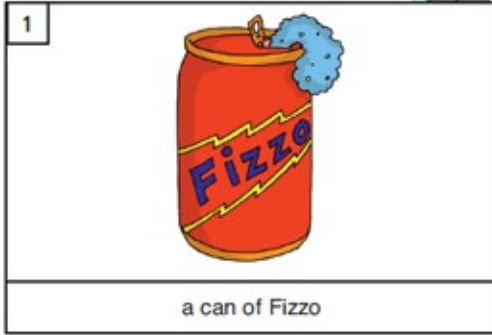

something to drink



Yes, please.



No, thanks.

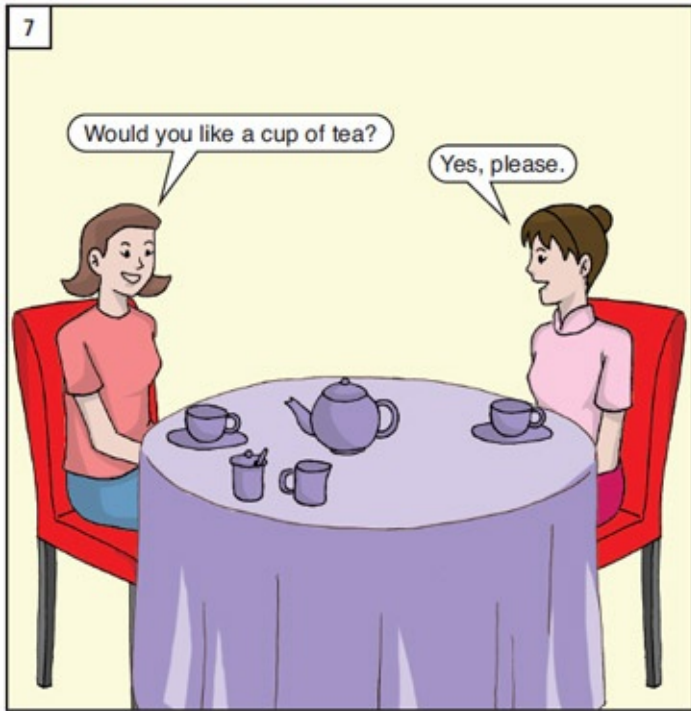
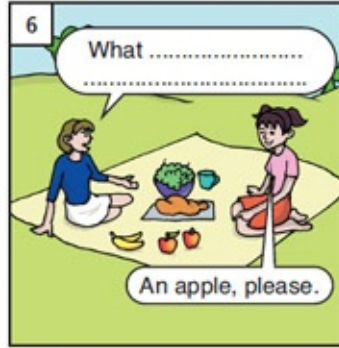

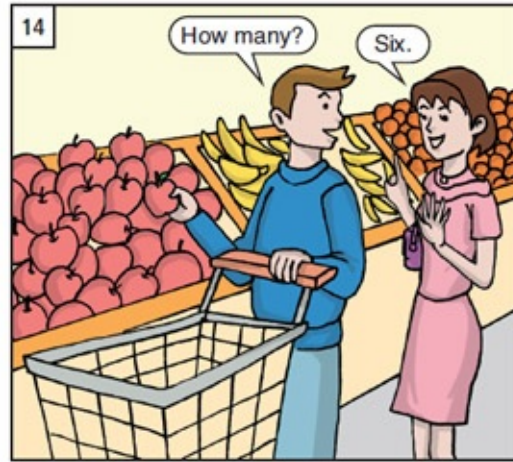
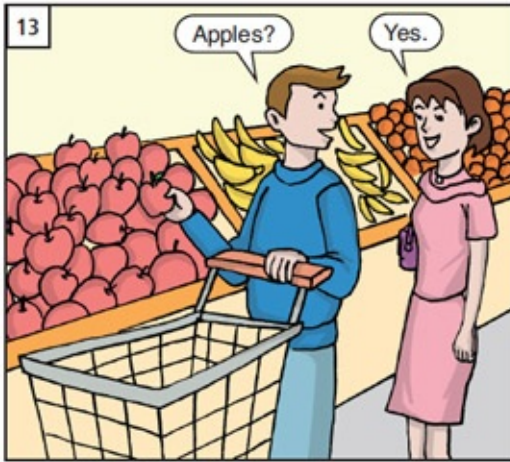
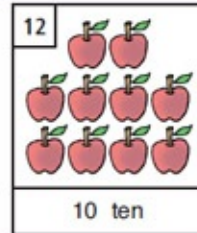
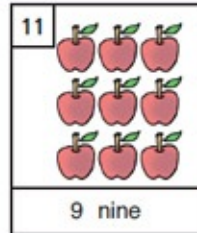
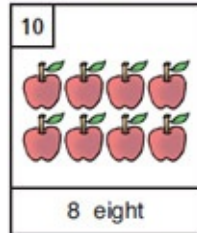
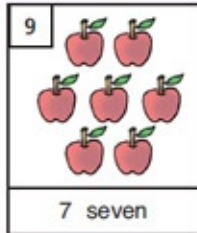
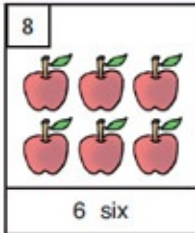
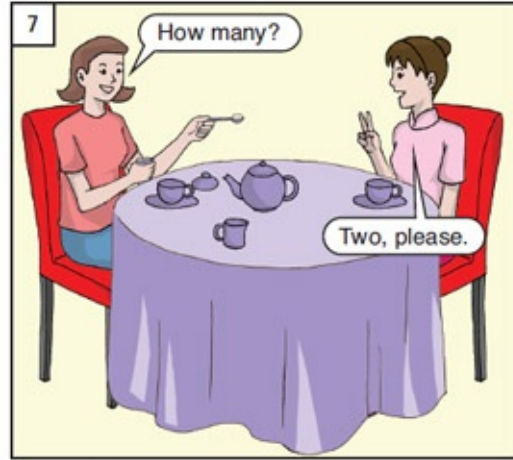
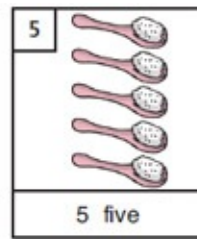
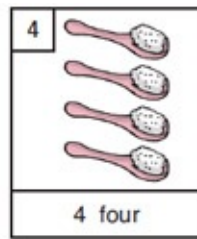
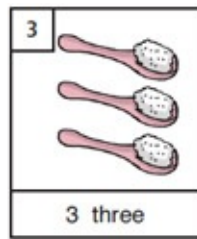
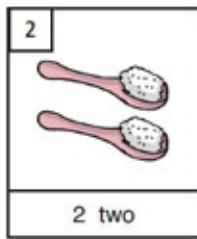
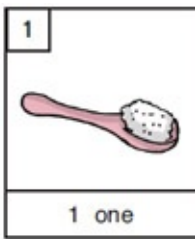

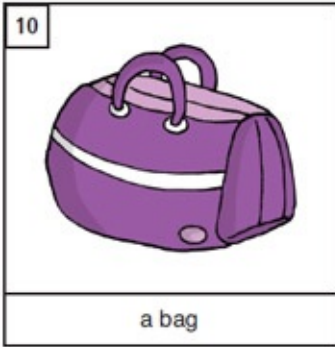
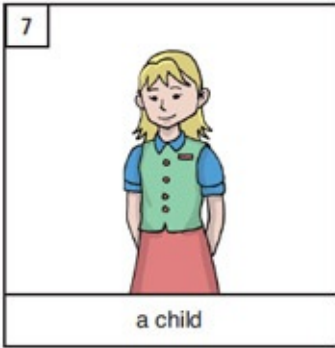
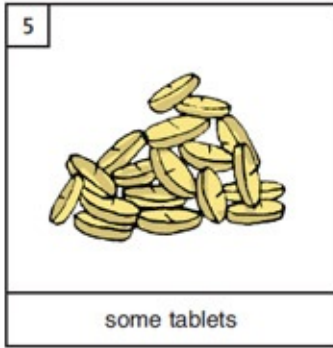
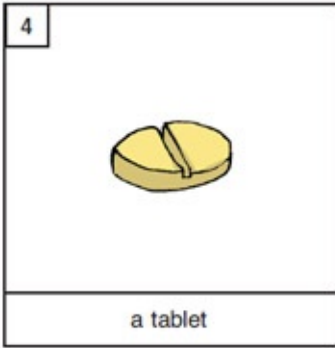
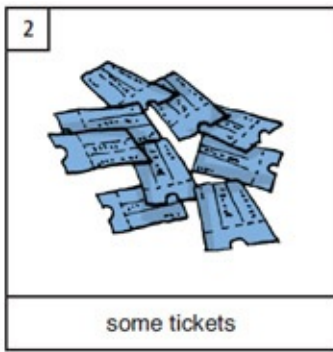
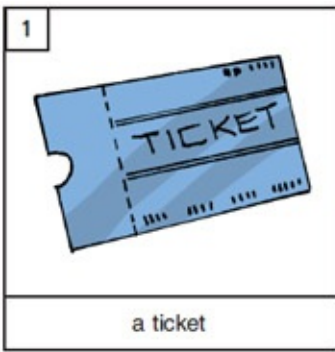

# The Bensons



## UNIT 7: He's a tour guide.

application form [æplikei'fɒn fɔ:rm]

occupation [a:kjəpei'fɒn]

now [naʊ]

too [tu:]

from [frʌm]

to [tu:]

hello [helou']

hi [haɪ]

did [dɪd]

was [wʌz]

were [wɛ:r]

when [wen]

Could you repeat that, please? [kud ju: rɪpi:t' ðæt pli:z]

I'm sorry. [aɪm sa:r'i:]

businessman [biz'nɪsmæn]

pharmacist [fa:r'məsɪst]

doctor [dɔ:k'tɔ:r]

nurse [nɜ:rs]

mechanic [mekæ'nɪk]

police officer [pəli:s'ɔ:fɪsɔ:r]

receptionist [rɪsep'fɒnɪst]

sales assistant [seɪlz əsɪs'tɒnt]

taxi driver [tæksɪ'draɪvɔ:r]

tour guide [tu:r aɪd]

What do you do? [wʌt du: ju: du:]

I'm a ... [aɪm ə]

have [hæv]

How many ... do you have? [haʊ men'i: du: ju: hæv]

slowly [slou'li:]

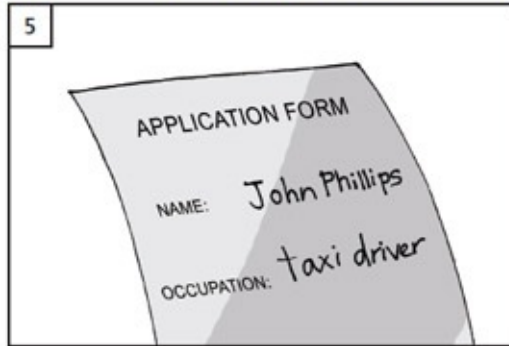



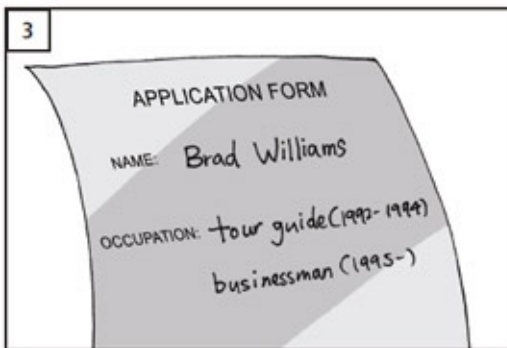

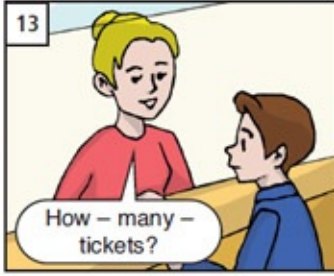
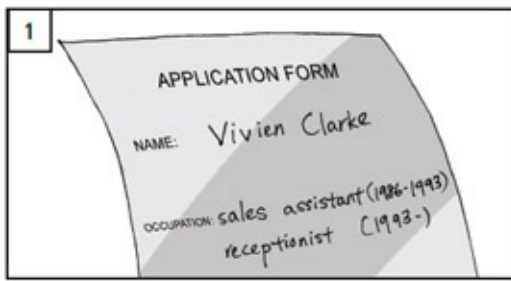

# The Bensons

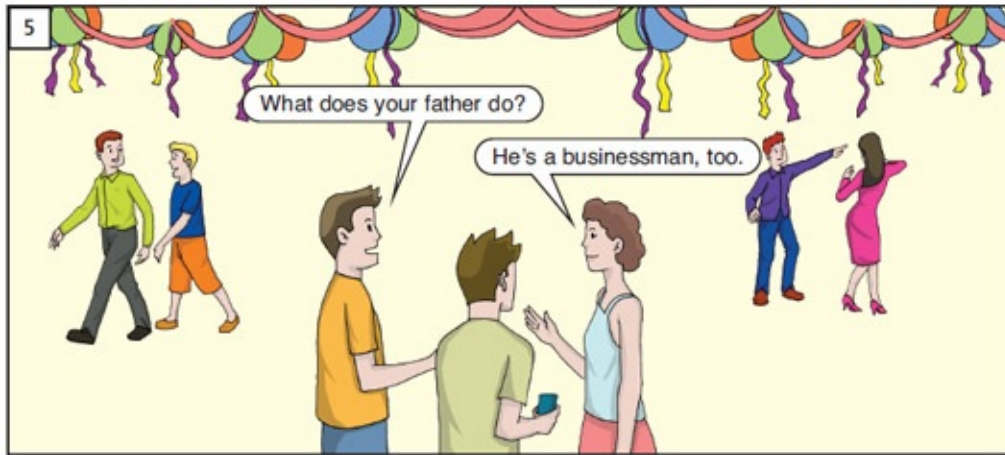
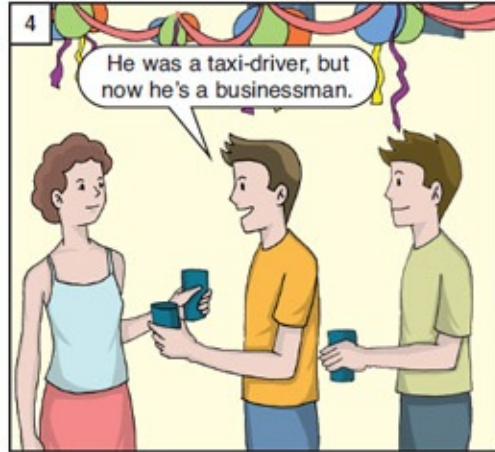



here is = here's

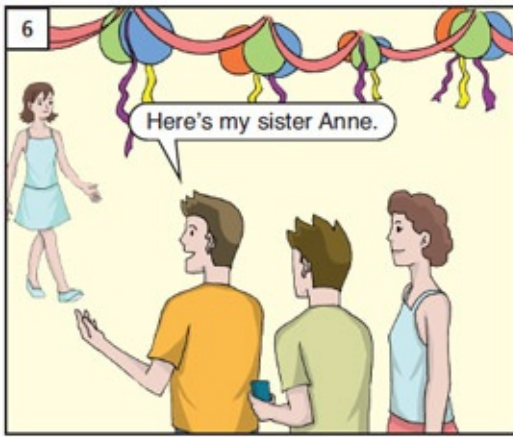

## UNIT 8: I'm going to New York.

How did you get here? [hau did ju: et hi:r]

How long have you been here? [hau lɔ:ŋ hæv ju: bin hi:r]

I'm from... [aim frʌm]

I've been here for... [aim frʌm]

Where are you from? [aiv bin hi:r fɔ:r]

arrive [we:r a:r ju: frʌm]

leave [əraivʹ]

eleven [ilɛv'ən]

twelve [twelv]

thirteen [θɜ:r'ti:n]

fourteen [fɔ:r'ti:n]

fifteen [fif'ti:n]

sixteen [siks'ti:n]

seventeen [sev'ənti:n]

eighteen [ei'ti:n]

nineteen [nain'ti:n]

twenty [twen'ti:]

everyone [ev'ri:wʌn]

How much...? [hau mʌtʃ]

dollars [dɔ:l'ɔ:rz]

cents [sents]

by [bai]

since [sins]

for [fɔ:r]

still [stil]

January [dʒænjʊwe:ri:]

February [feb'jəwe:ri:]

March [mɑ:rtʃ]

April [eip'rəl]

May [mei]

June [dʒu:n]

July [dʒʌlaiʹ]

August [ɔ:g'əst]

September [septem'bɜ:r]

October [a:ktəbɜ:r]

November [nouvem'bɜ:r]

December [disem'bɜ:r]

Monday [mʌn'dei]

Tuesday [tu:z'dei]

**Wednesday** [wenz 'dei]

**Thursday** [θə:rZ'dei]

**Friday** [frai 'dei]

**Saturday** [sæt 'ə:rdei]

**Sunday** [sʌn'dei]

**month** [mʌnθ]

**week** [wi:k]

**weekend** [wi:k 'end]

**year** [ji:r]

**day** [dei]

**school** [sku:l]

**bus** [bʌs]

**plane** [plein]

**train** [trein]

1

**\$**

dollars

**¢**

cents

2

How much is this pen?

It's eleven dollars.

= \$11

3

How much is this wallet?

It's twelve dollars.

= \$12

4

How much is that book?

It's thirteen dollars.

= \$13

5

How much is that purse?

It's fourteen dollars.

= \$14

6

fifteen dollars

sixteen dollars

seventeen dollars

eighteen dollars

nineteen dollars

twenty dollars

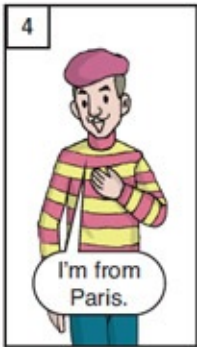
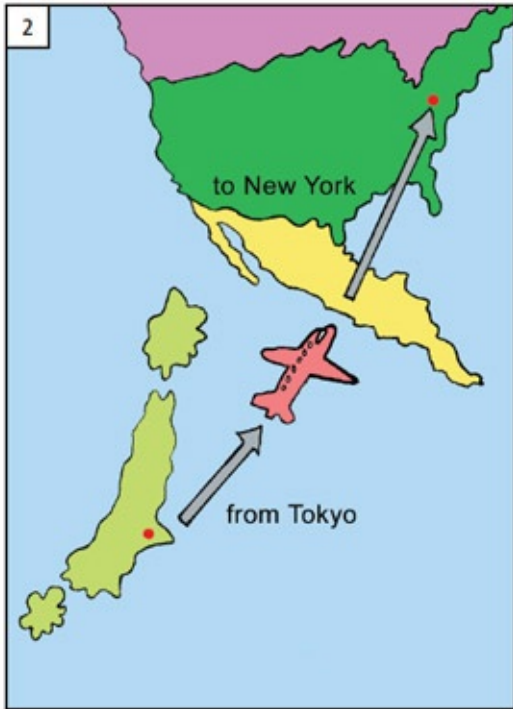



1

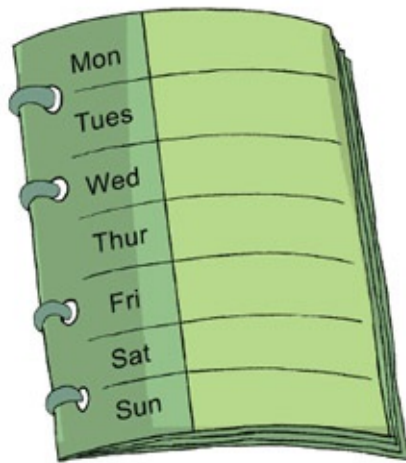

seven days = one week

Mon	Tues	Wed	Thurs	Fri	Sat	Sun
Monday	Tuesday	Wednesday	Thursday	Friday	Saturday	Sunday
					Weekend	

2

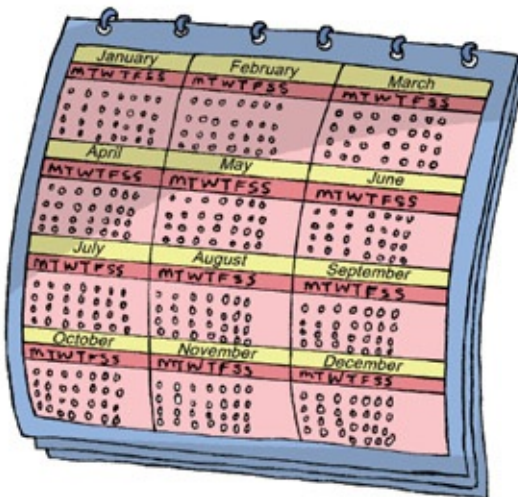

twelve months = one year

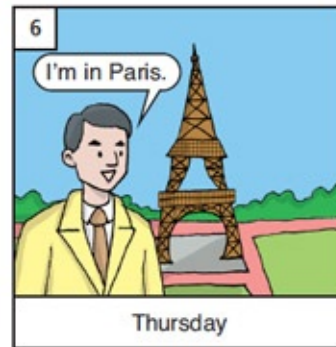
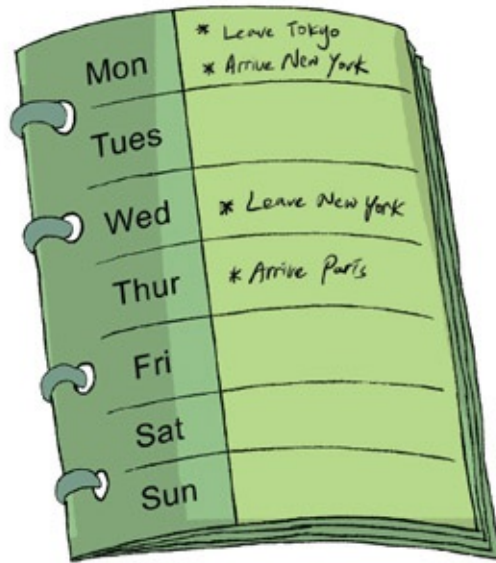

 I have = I've

 we have = we've

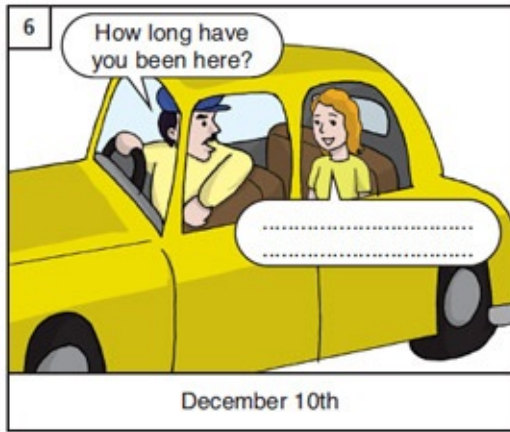
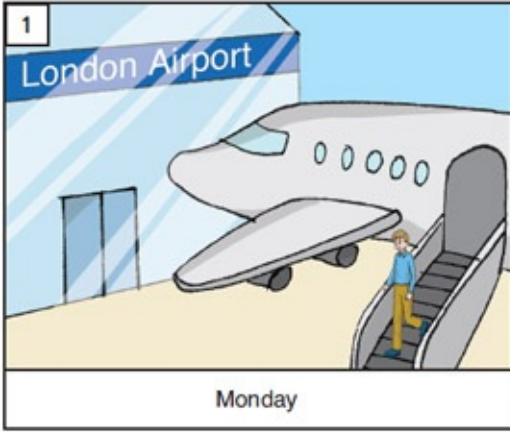



# The Bensons



## UNIT 9: This one is better.

rice [raɪs]  
bread [bred]  
potato [pə'teɪ'təʊ]  
pasta [pɑ:s'tə]  
peas [pi:z]  
onion [ʌn'jən]  
carrot [kær'ət]  
tomato [tə'meɪ'təʊ]  
beans [bi:nz]  
cauliflower [kɔ:'leɪflaʊə:r]  
cabbage [kæb'ɪdʒ]  
broccoli [brɑ:k'ɒli:]  
cucumber [kju:'kʌmbə:r]  
lettuce [let'ɪs]  
mushroom [mʌʃ'ru:m]  
ice cream [aɪs kri:m]

big [bɪ]  
small [smɔ:l]  
boring [bɔ:r'ɪŋ]  
interesting [ɪn'trɪstɪŋ]  
cheap [tʃi:p]  
expensive [ɪkspen'sɪv]  
tall [tɔ:l]  
short [ʃɔ:rt]  
heavy [he'vi:]  
light [laɪt]  
wide [waɪd]  
narrow [nær'əʊ]  
good [ʊd]  
bad [bæd]

bigger [bɪ'gə:r]  
smaller [smɔ:'lə:r]  
more boring [mɔ:r bɔ:r'ɪŋ]  
more interesting [tʃi:'pə:r]  
cheaper [mɔ:r ɪkspen'sɪv]  
more expensive [mɔ:'ɛkspən'sɪv]  
taller [tɔ:rt'ə:r]  
shorter [ʃɔ:rt'ə:r]

heavier [he'vi:ə:r]

lighter [lait'ə:r]

wider [waid'ə:r]

narrower [nær'ouə:r]

better [bet'ə:r]

worse [wə:rs]

biggest [bi'ɪst]

smallest [smɔ:'list]

most boring [moust bɔ:r'ɪŋ]

most interesting [moust in'trɪstɪŋ]

cheapest [tʃi:'pɪst]

most expensive [moust ɪkspen'sɪv]

tallest [tɔ:'list]

shortest [ʃɔ:rt'ɪst]

heaviest [he'vi:ɪst]

lightest [lait'ɪst]

widest [waid'ɪst]

narrowest [nær'ouɪst]

best [best]

worst [wɔ:rst]

very [ve:r'i:]

very much [ve:r'i: mʌtʃ]

agree [əgri:]

think [θɪŋk]

like [laɪk]

What do you think? [wʌt du: ju: θɪŋk]

Do you like... ? [du: ju: laɪk]

Can I help you? [kæn ai help ju:]

suitcase [su:t'keɪs]

pair of sunglasses [pe:r ʌv sʌn'glæsɪz]

cap [kæp]

surfboard [sə:rf'bɔ:rd]

basketball player [bæs'kitbɔ:l plei'ə:r]

jockey [dʒə:k'i:]

horse [hɔ:rs]



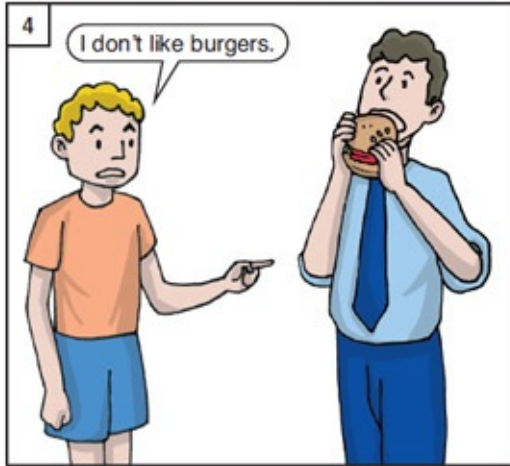
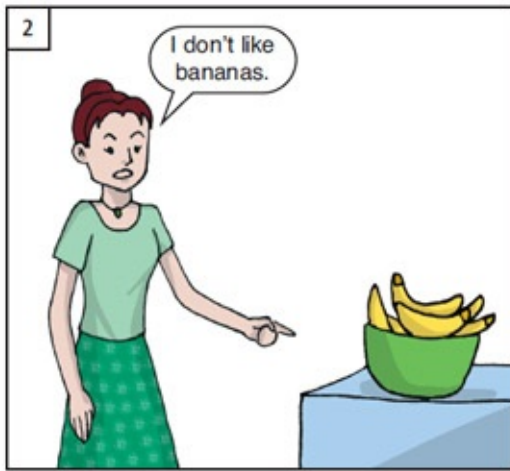
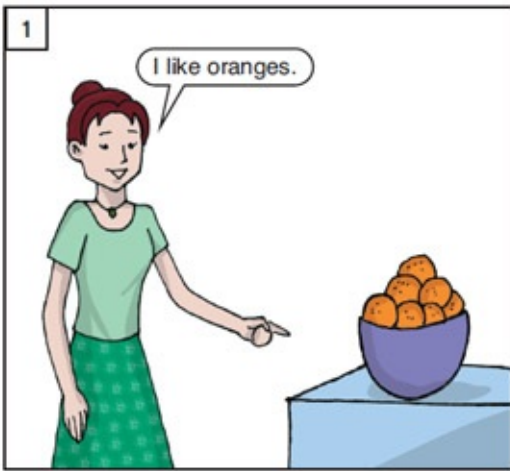







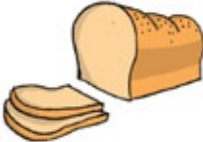



pants [pænts]







Do you like...?

1  bread	2  potatoes	3  rice
4  pasta	5  onions	6  peas
7  carrots	8  tomatoes	9  beans
10  cauliflower	11  cabbage	12  broccoli
13  cucumber	14  lettuce	15  mushrooms



Yes, I do.



No, I don't.

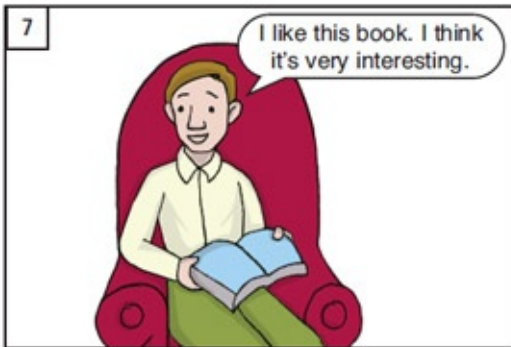
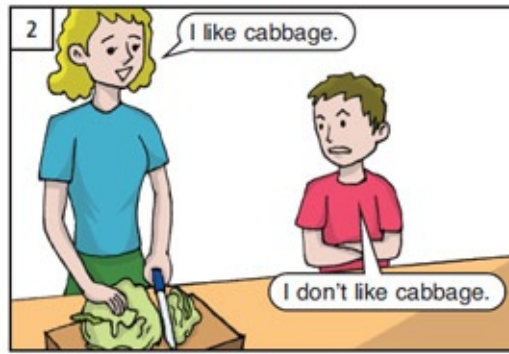



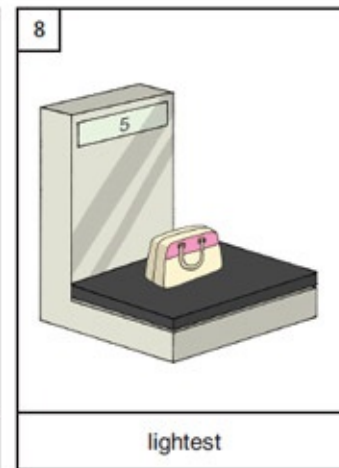
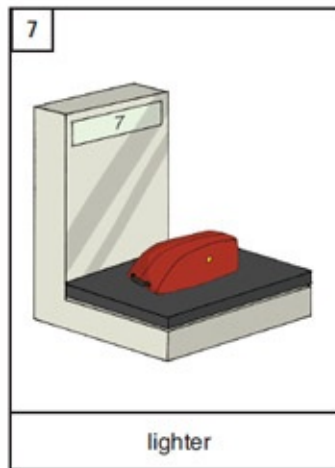
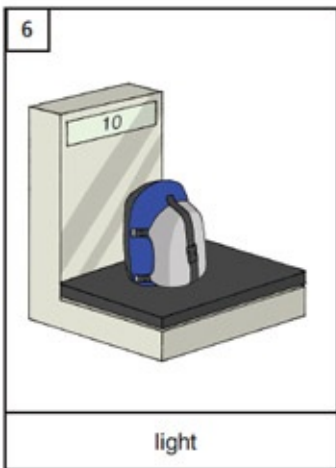
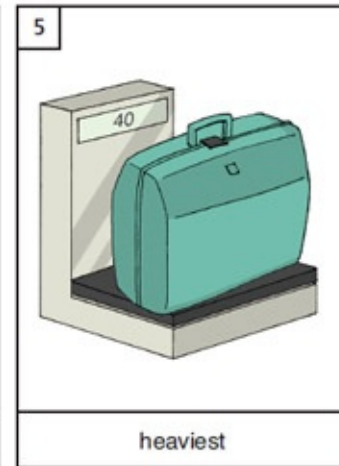
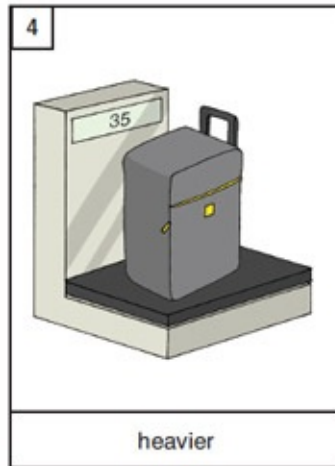
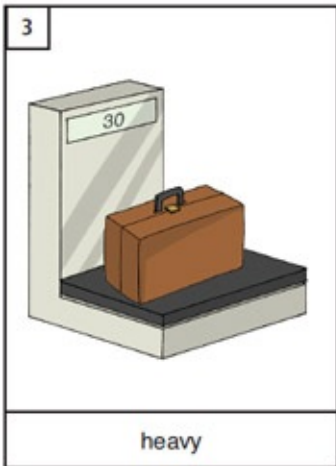
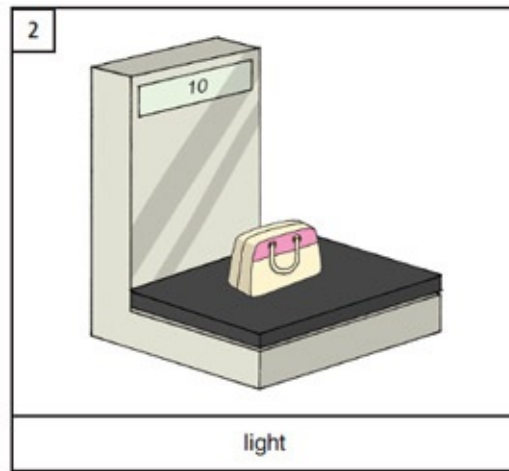
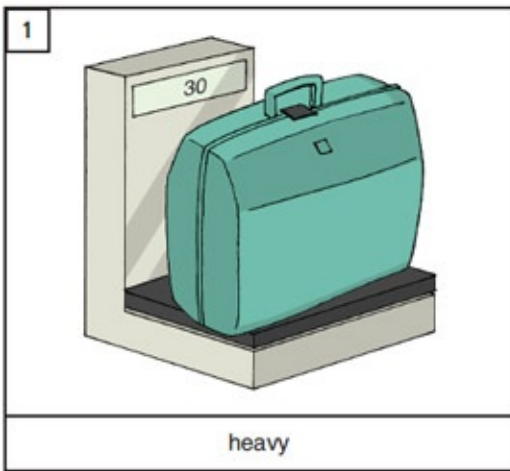

1



a pair of sunglasses

2



expensive      more expensive      most expensive

3



cheap      cheaper      cheapest

4

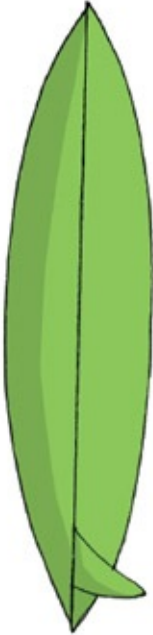

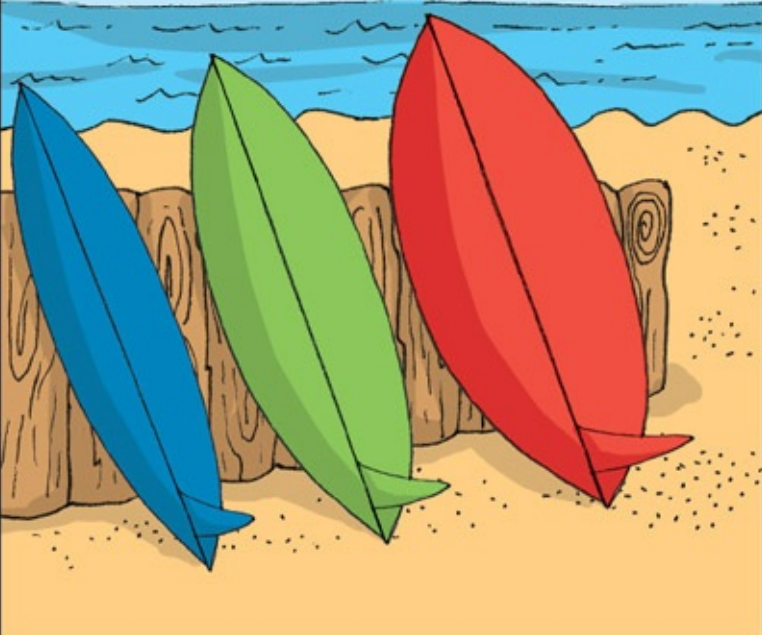

a surfboard

5



wide      wider      widest

<p>1</p> 			
<p>pants</p>	<p>narrow</p>	<p>narrower</p>	<p>narrowest</p>

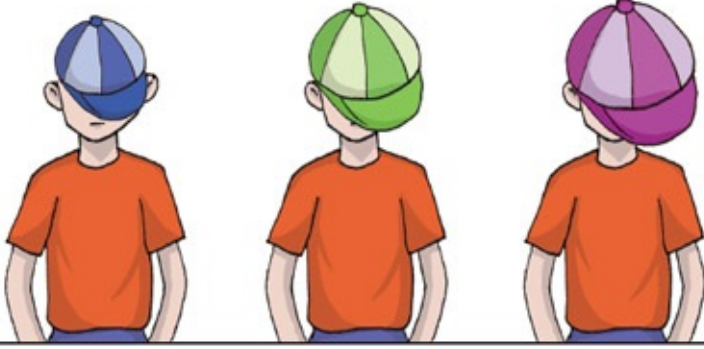
<p>2</p> 			
<p>a cap</p>	<p>big</p>	<p>bigger</p>	<p>biggest</p>

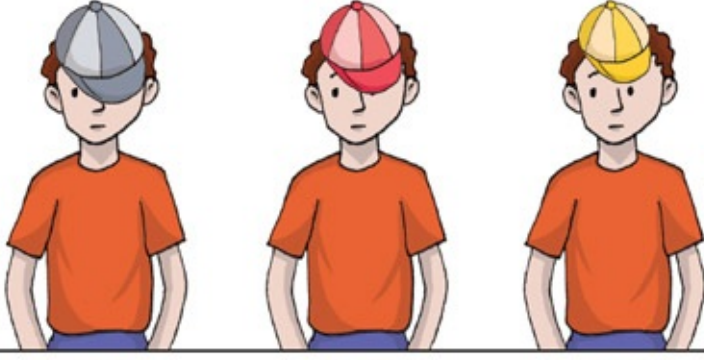
<p>3</p> 			
<p>a cap</p>	<p>small</p>	<p>smaller</p>	<p>smallest</p>

1

good      better      best

2

bad      worse      worst

3

RESTAURANT      RESTAURANT

I think this restaurant is good. What do you think?

4

RESTAURANT      RESTAURANT

I think this one is better.

5

I like that suitcase. What do you think?

6





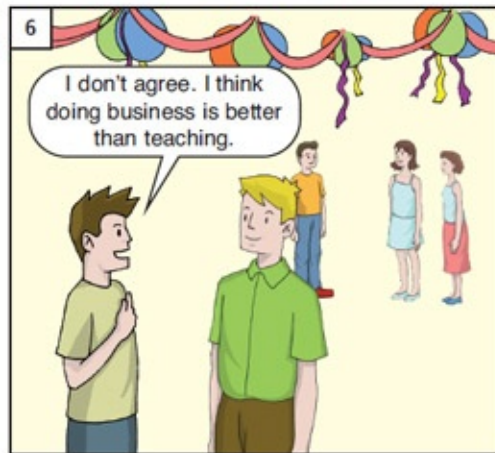
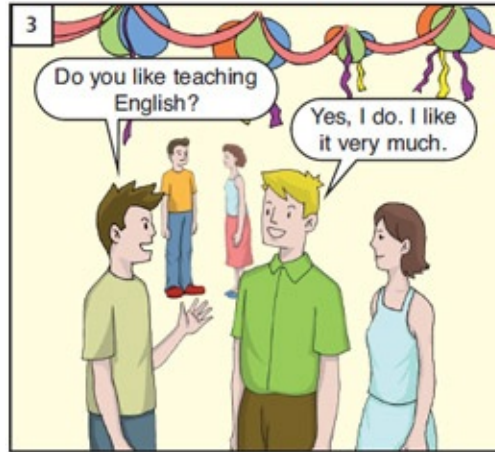













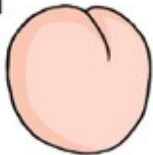

Yes, I think it's a good one, but that one is better. I like it very much.

# The Bensons





# UNIT 10: Revision and extension

1  apple .....	2  .....	3  .....	4  .....
5  .....	6  .....	7  .....	8  .....
9  .....	10  .....	11  .....	12  .....
13  .....	14  .....	15  .....	16  .....
17  .....	18  .....	19  .....	20  .....



**A**

1. Would you like a glass of milk?
2. She's tall, isn't she?
3. Do you like this restaurant?
4. What would you like?

- a. An apple would be nice.
- b. No, I don't.
- c. No, thank you.
- d. Yes, she is.

**B**

1. What do you do?
2. What did you do?
3. When were you a teacher?

- a. He was a police officer.
- b. I was a teacher.
- c. From 1991 to 1996.

4. What did your brother do?

d. I'm a taxi driver.

**C**

1. Where are you from?

a. Three weeks.

2. How long have you been here?

b. Yes, I do.

3. How did you get here?

c. By train.

4. Do you like this hotel?

d. I'm from Tokyo.

**D**

1. This watch is expensive.

a. This one is bigger.

2. This house is big.

b. This one is more expensive.

3. Those books are cheap.

c. Alan runs faster.

4. Max runs fast.

d. These are cheaper.



can't

take

too

I

you

your



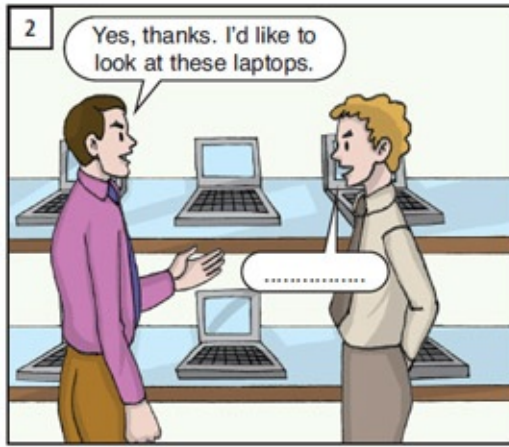

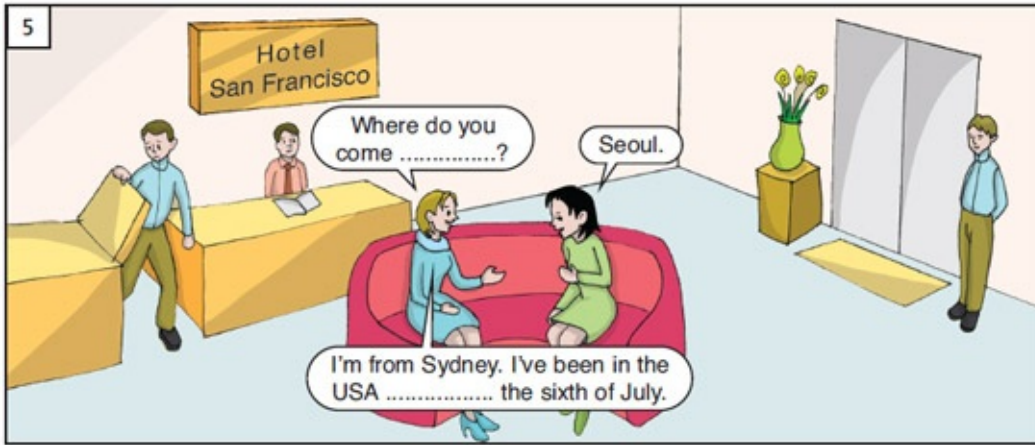



- > to something you eat Would like
- > be nice chips Some would



- > cup you coffee Would a of like
- > please Yes

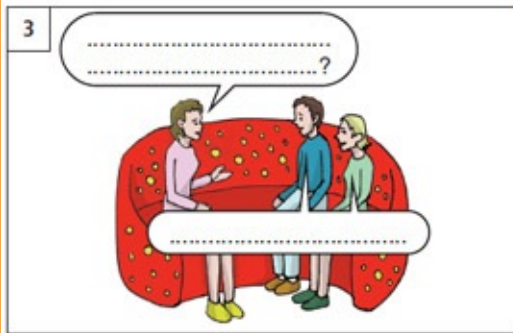

- > here you long have How been
- > months two For



- > here been How you long have
- > seventeenth Since September of the



- > get did you here How
- > taxi By

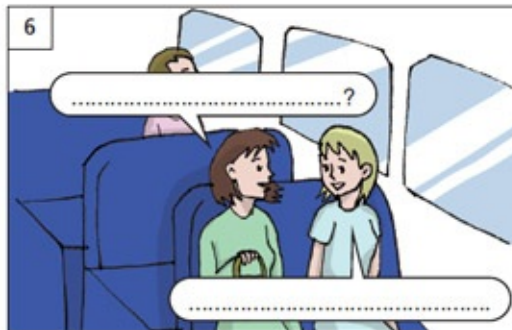

- > from Where you are
- > San Francisco from I'm





- > Los Angeles of What think you do
- > I interesting is think more San Francisco

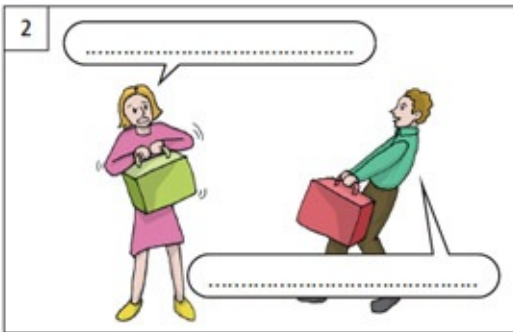

- > is suitcase This heavier
- > this one bigger Yes is but



- > ??????????????????????
- > sorry that repeat Could please I'm you



- > like movie you the Did
- > boring No was It



- > cake like you Do
- > much Yes very I it like



- > you do do What
- > manager a I'm

**UNIT 10: Answers**

**Unit 10, page 82**

1. apple
2. bag
3. banana
4. cookie

5. beans
  6. chips
  7. tomatoes
  8. cucumber
  9. peach
  10. plum
  11. suitcase
  12. nurse
  13. bottle of orange juice 14. nuts
  15. orange
  16. piece of cake
  17. sandwich
  18. peas
  19. cap
  20. tablets
- 

**Unit 10, page 83**

21. ticket
22. lettuce
23. onions
24. bread
25. doctor
26. teacher
27. mechanic
28. police officer
29. receptionist
30. sales assistants
31. taxi driver
32. tea
33. bus
34. train
35. burger
36. socks
37. sausage
38. mushrooms
39. pair of sunglasses 40. carrots

---

Unit 10, page 84

- A. 1c 2d 3b 4a
  - B. 1d 2b 3c 4a
  - C. 1d 2a 3c 4b
  - D. 1b 2a 3d 4c
- 

Unit 10, page 85

- 1. something
  - 2. piece of, glass of 3. Can
  - 4. like
  - 5. eat
- 

Unit 10, page 86

- 1. I
  - 2. your, too
  - 3. you
  - 4. take, can't
- 

Unit 10, page 87

- 1. me
  - 2. Sure
  - 3. most
  - 4. isn't it, heavier
  - 5. about 6. do, looks
- 

Unit 10, page 88

- 2. here, by
  - 3. long, For
  - 4. think, much, agree 5. from, since
- 

Unit 10, page 89

- 1. Would you like something to eat? Some chips would be nice.

**2. Would you like a cup of coffee? Yes, please.**

**3. How long have you been here? For two months.**

**4. How long have you been here? Since the seventeenth of September.**

**5. How did you get here?**

**By taxi.**

**6. Where are you from?**

**I'm from San Francisco.**

---

**Unit 10, page 90**

**1. What do you think of Los Angeles?**

**I think San Francisco is more interesting.**

**2. This suitcase is heavier.**

**Yes, but this one is bigger.**

**3. I'm sorry. Could you repeat that please?**

**4. Did you like the movie?**

**No. It was boring.**

**5. Do you like cake?**

**Yes. I like it very much.**

**6. What do you do?**

**I'm a manager.**

## UNIT 11: What's the matter?

Are you all right? [a:r ju: ɔ:l rait]

What's the matter? [wʌts ðə mæt'ə:r]

What's wrong? [wʌts rɔ:ŋ]

Sorry. [sɑ:r 'ɪ:]

I'm sorry to hear that. [aim sa:r'ɪ: tu: hi:r ðæt]

Thanks for coming. [θæŋks fɔ:r kʌm'ɪŋ]

back [bæk]

ear [i: r]

foot [fʊt]

hand [hænd]

head [hed]

knee [ni:]

leg [le]

arm [ɑ:rm]

shoulder [ʃəʊl'də:r]

stomach [stʌm'æk]

tooth [tu:θ]

Good morning. [gʊd mɔ:r'nɪŋ]

Good afternoon. [gʊd æftə:rnu:n]

Good evening. [gʊd i:v'nɪŋ]

Good night. [ʊd naɪt]

Goodbye. [ʊdbaɪ ']

Bye. [baɪ]

See you later. [si: ju: lei'tə:r]

Have a nice day. [hæv ə naɪs deɪ]

bill [bɪl]

hurts [hɜ:rts]

headache [hed'eɪk]

backache [bæk'eɪk]

stomachache [stʌm'əkeɪk]

earache [i:r'eɪk]

toothache [tu:θ'eɪk]

Keep right. [ki:p rait]

go home [əʊ haʊm]

have to [hæv tu:]

pay [peɪ]

stop [stɒp]

take [teɪk]

sun [sʌn]

moon [mu:n]

stars [stɑ:z]

morning [mɔ:r'nɪŋ]

afternoon [æftə:nu:n]

evening [i:v'nɪŋ]

night [naɪt]

day [deɪ]

Dad [dæd]

morning + afternoon + evening + night = 1 day

1 the sun

2 the moon

3 the stars

4 morning

5 afternoon

6 Good morning. Good morning.

7 Good afternoon. Good afternoon.

8 evening

9 night

10 Good evening. Good evening.

11 Good night, Mark. Good night, Dad.



John is = John's



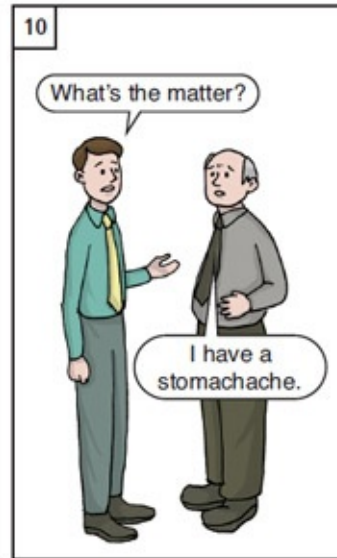
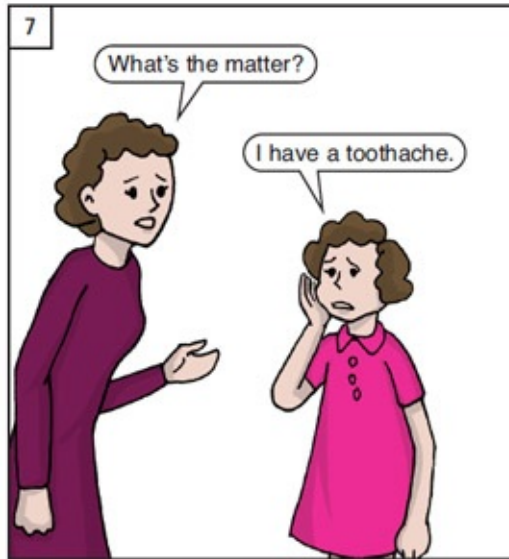
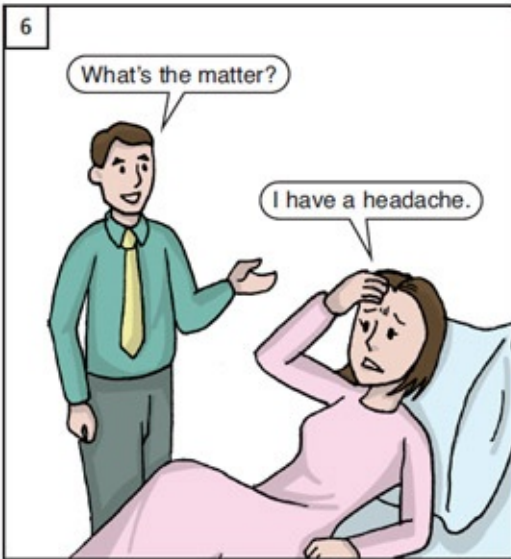
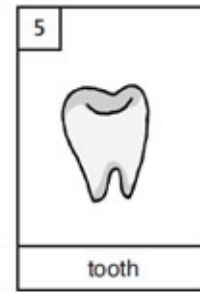
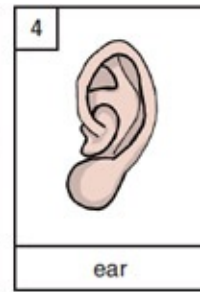



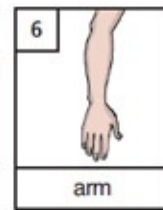
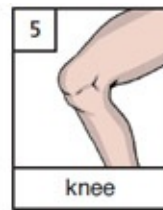
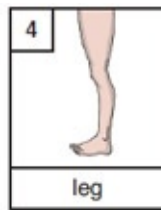
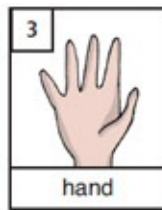



# The Bensons

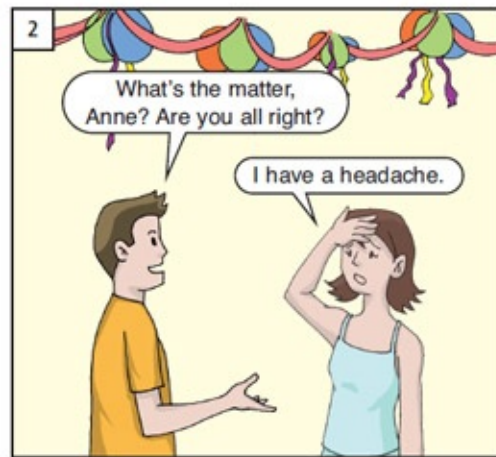
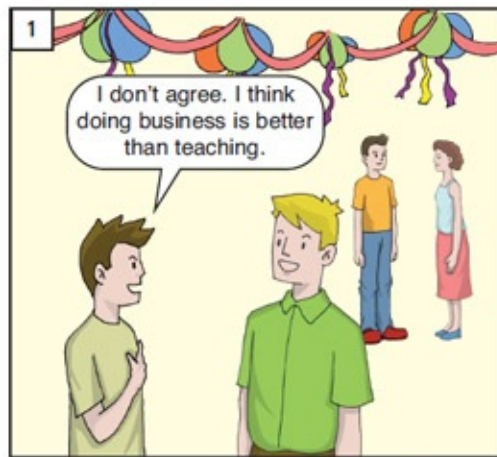

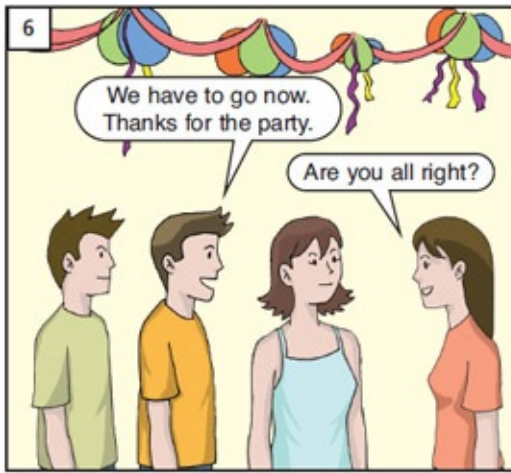

## UNIT 12: I live In the big house.

Where do you live? [weɪr du: ju: liv]

What's your address? [wɒts ju:r ədresʹ]

I live at... [ai liv æt]

call [kɔ:l]

get [et]

I'll [aɪl]

will [wɪl]

hospital [hɑ:s'pɪtəl]

police station [pəli:s' steɪʹʃən]

twenty-one [twen'ti: wʌn]

twenty-two [twen'ti: tu:]

twenty-three [twen'ti: θri:]

twenty-four [twen'ti: fɔ:r]

twenty-five [twen'ti: faɪv]

twenty-six [twen'ti: sɪks]

twenty-seven [twen'ti: sev'ən]

twenty-eight [twen'ti: eit]

twenty-nine [twen'ti: nain]

thirty [ðɜ:r'ti:]

near [ni:r]

next door [nekst dɔ:r]

next to [nekst tu:]

opposite [ə'pəzɪt]

at [æt]

on [ɔ:n]

corner [kɔ:r'nɜ:r]

around the corner [əraʊnd' ðə kɔ:r'nɜ:r]

on the corner [ɔ:n ðə kɔ:r'nɜ:r]

street [stri:t]

road [rɔ:ɪd]

address [ədresʹ]

card [kɑ:rd]

thirty-one [ðɜ:r'ti: wʌn]

forty [fɔ:r'ti:]

fifty [fɪf'ti:]

sixty [sɪks'ti:]

seventy [sev'ən ti:]

eighty [ei'ti:]

ninety [naɪnˈti:]

one hundred [wʌn hʌndrɪd]

two hundred and one [tuː hʌndrɪd ænd wʌn]

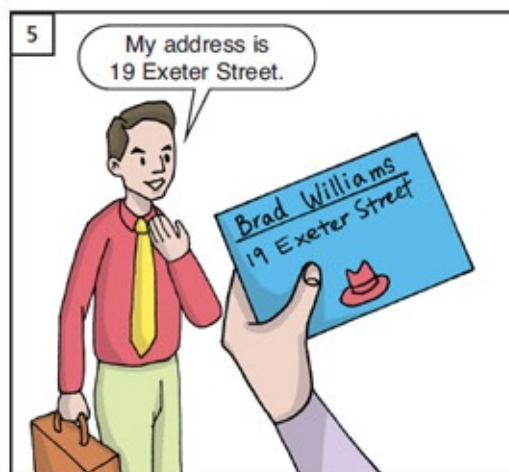

<b>21</b> twenty-one	<b>22</b> twenty-two	<b>23</b> twenty-three	<b>24</b> twenty-four	<b>25</b> twenty-five
<b>26</b> twenty-six	<b>27</b> twenty-seven	<b>28</b> twenty-eight	<b>29</b> twenty-nine	<b>30</b> thirty

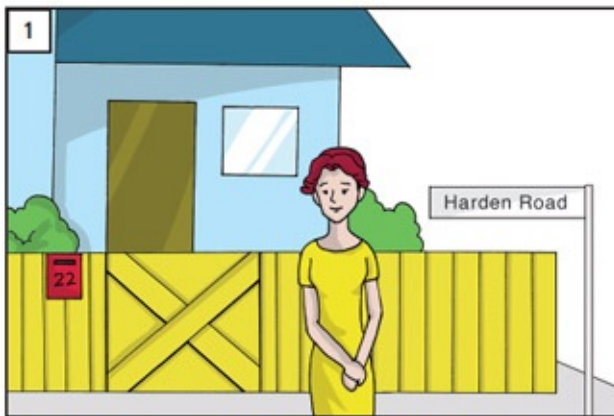

<b>31</b> thirty-one	<b>40</b> forty	<b>50</b> fifty	<b>60</b> sixty	<b>70</b> seventy
<b>80</b> eighty	<b>90</b> ninety	<b>100</b> one hundred	<b>200</b> two hundred	<b>201</b> two hundred and one

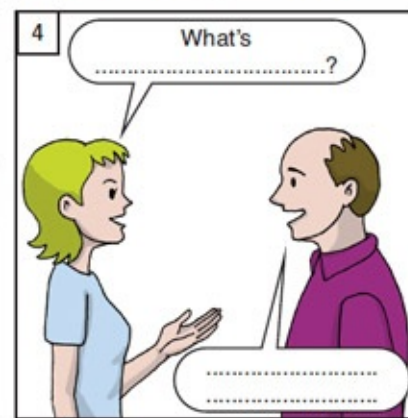

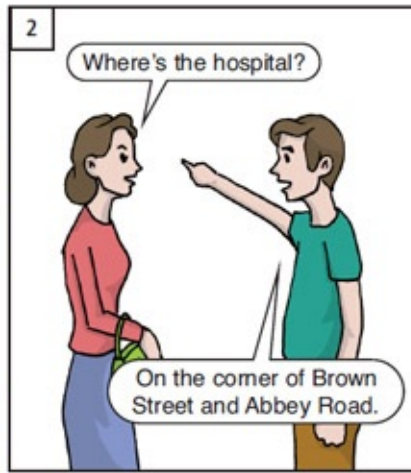
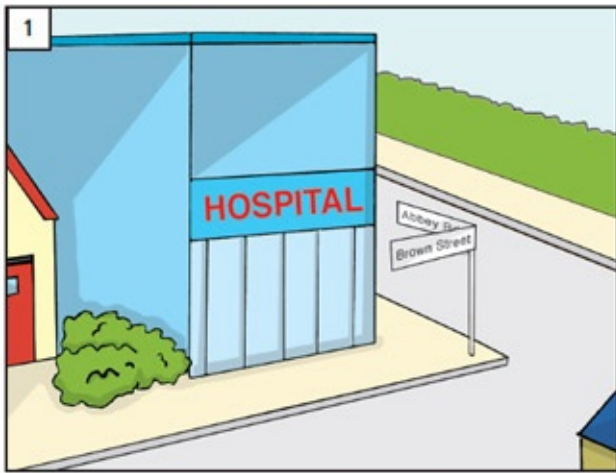



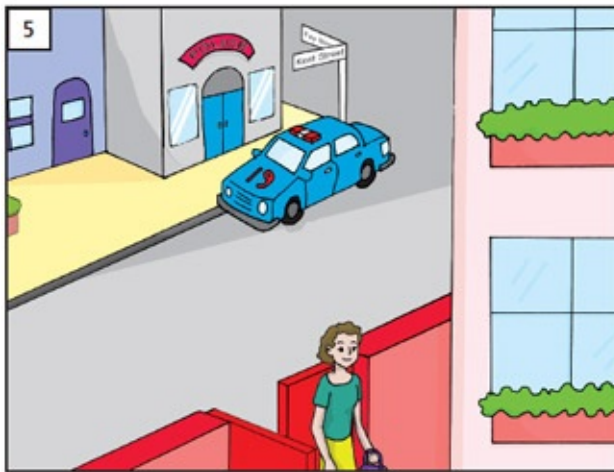
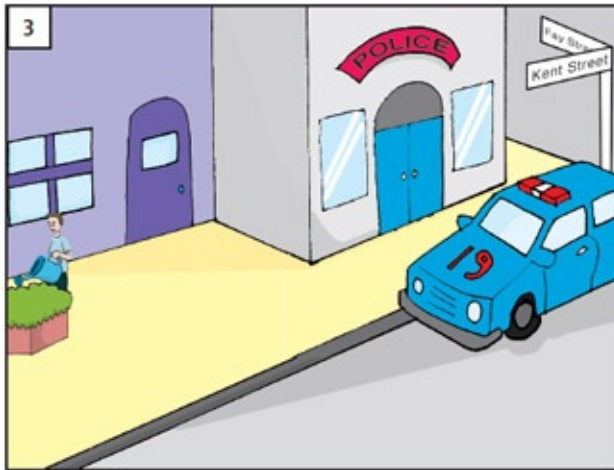
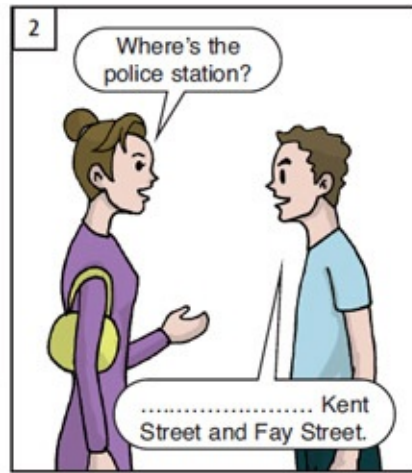
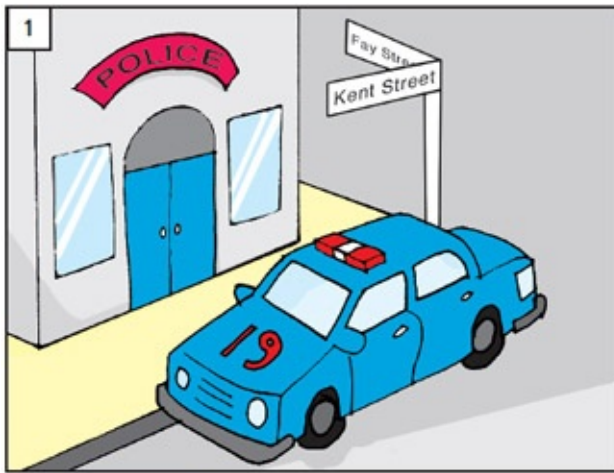

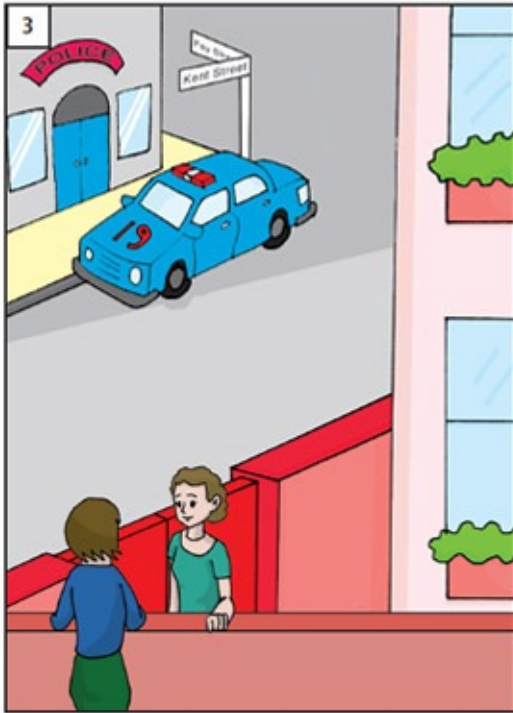

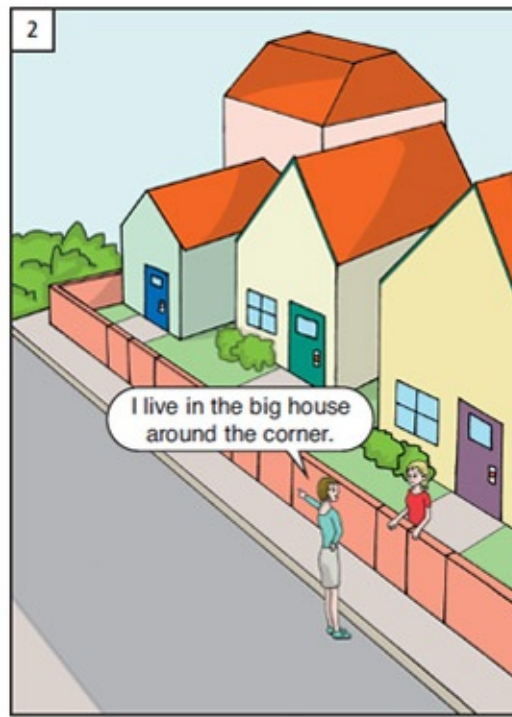

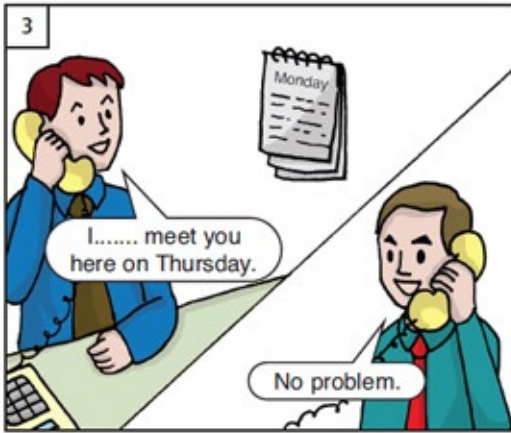

# The Bensons

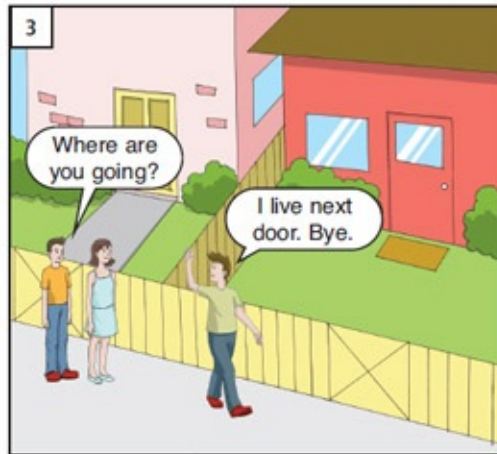

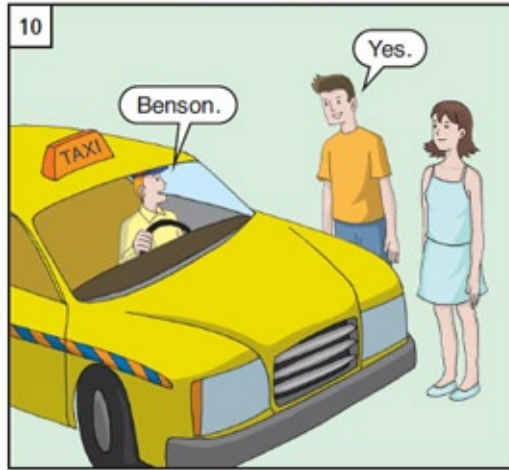
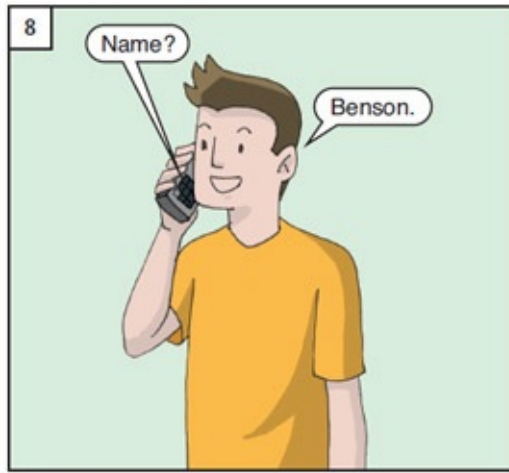

## UNIT 13: How much is this purse?

Do [du:]

Do you take... ? [du: ju: teik]

Do you have... ? [du: ju: hæv]

cash [kæʃ]

credit card [kred 'it ka:rd]

How's your ... now? [haʊz ju:r ... nau]

You should ... [ju: ʃu:d]

play [plei]

piano [pi:æ'nəʊ]

guitar [ita:r ']

trumpet [trʌm'pit]

violin [vaiəlin']

bag [bæg]

tube [tu:b]

carton [ka:r'tɒn]

box [bɒks]

window [wɪn'dəʊ]

door [dɔ:r]

floor [flɔ:r]

ceiling [si:'liŋ]

wall [wɔ:l]

room [ru:m]

waiting room [wei'tɪŋ ru:m]

some [sʌm]

any [en 'i:]

No problem. [nəʊ pra:b'ləm]

That's okay. [ðæt s oukei']

or [ɔ:r]

drugstore [drʌg'stɔ:r]

egg [e]

toothpaste [tu:θ'peɪst]

toothbrush [tu:θ'brʌʃ]

make [meik]

need [ni:d]

wait [weit]

old [ould]

new [nu:]

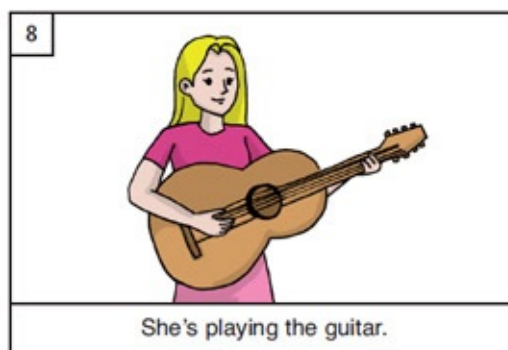
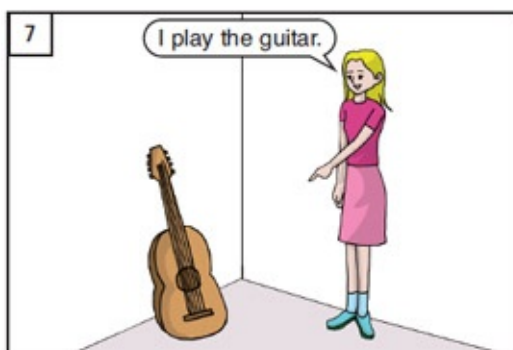
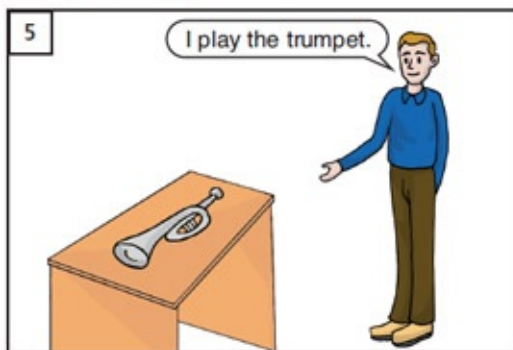



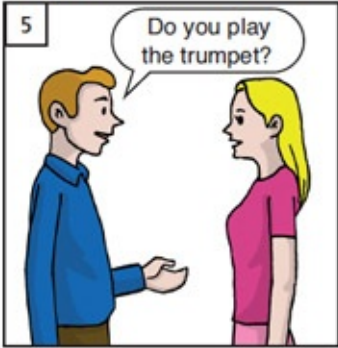
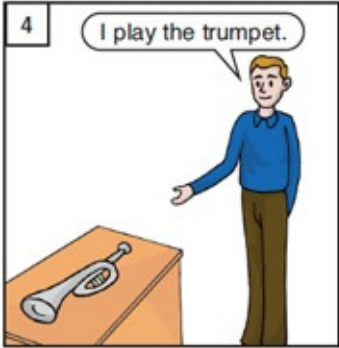

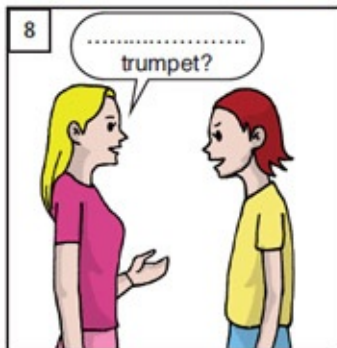
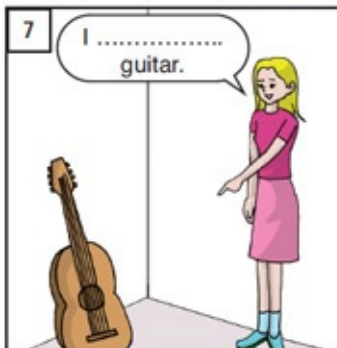
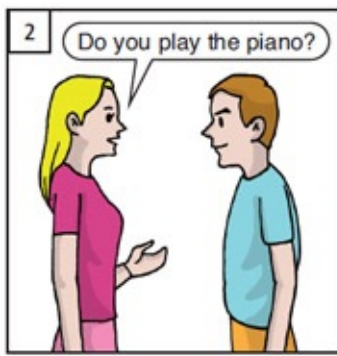
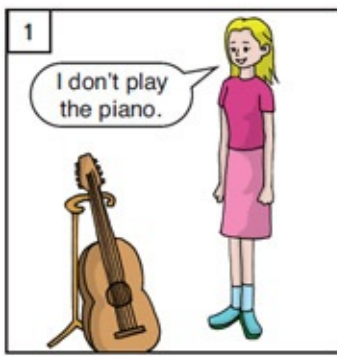

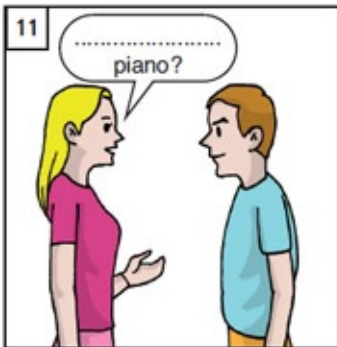
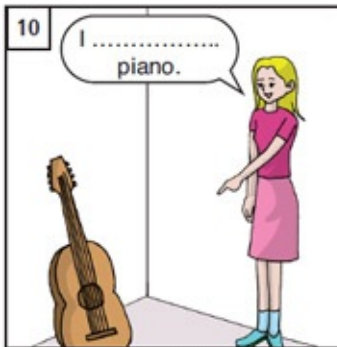
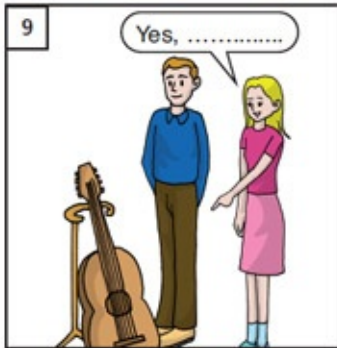
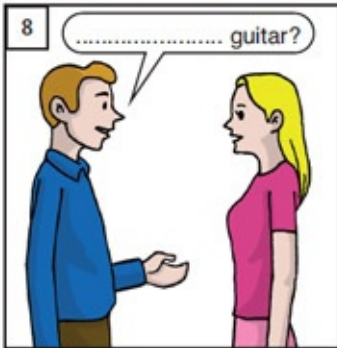
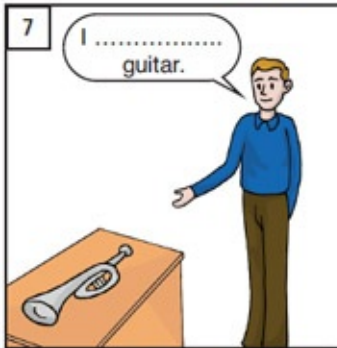
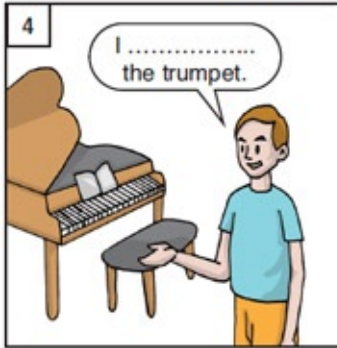
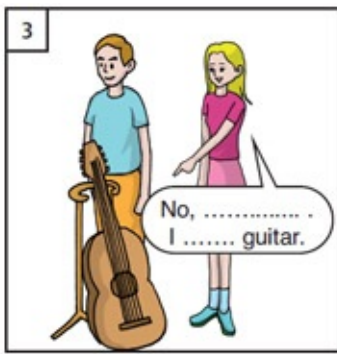
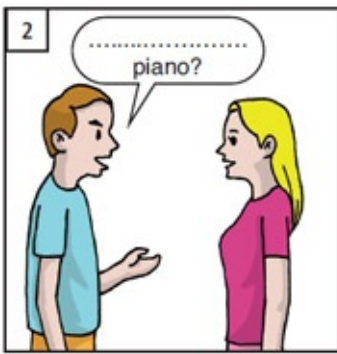

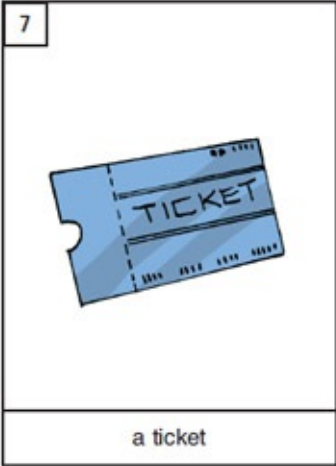
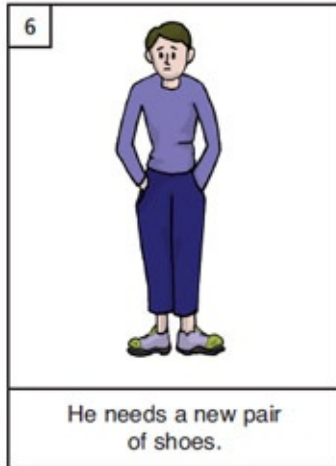
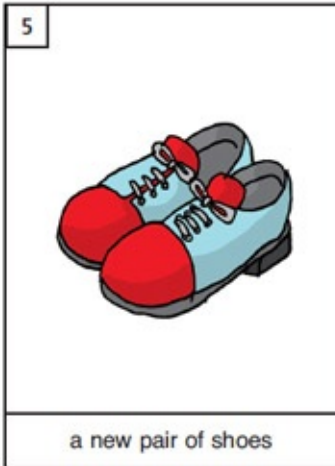
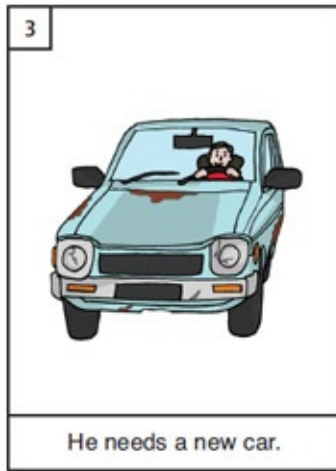
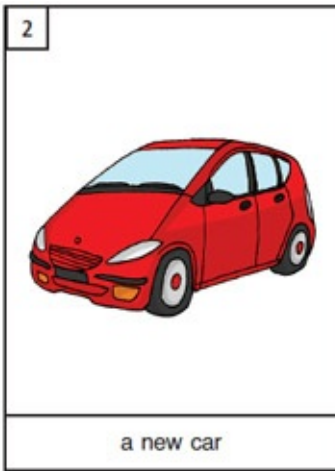



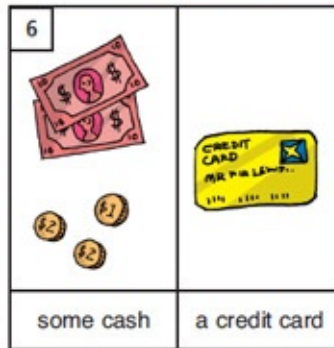

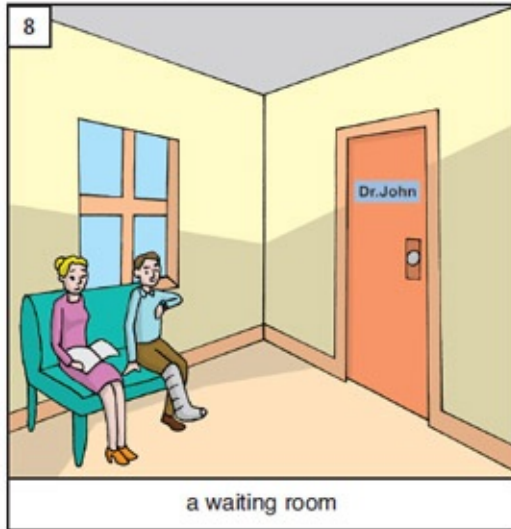
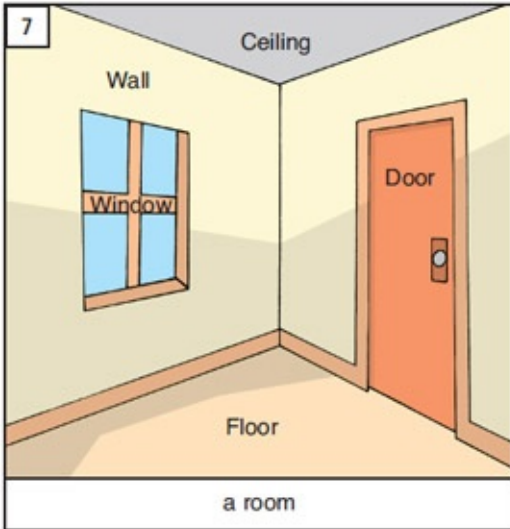
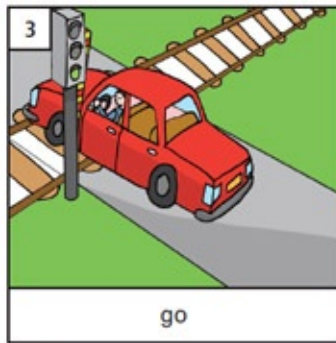
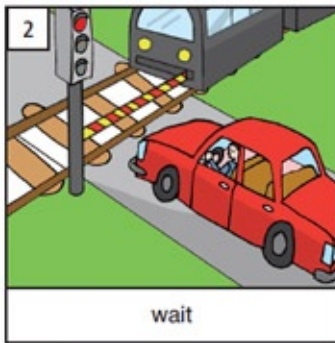
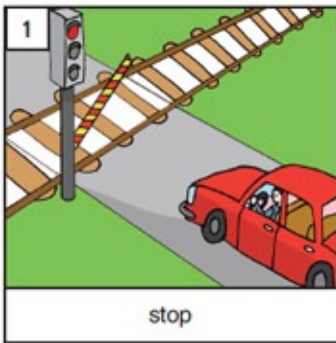



how is =

how's

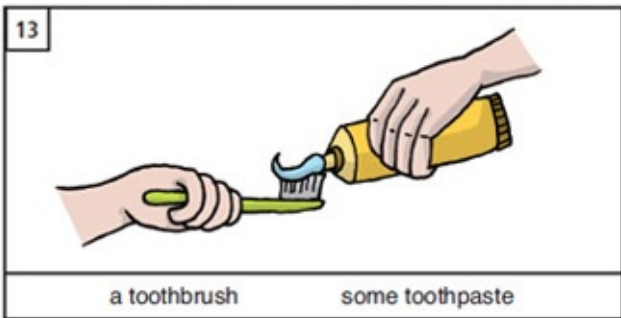
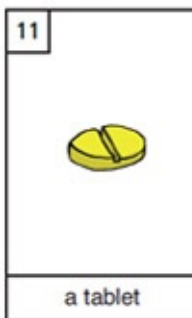
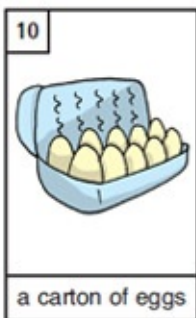
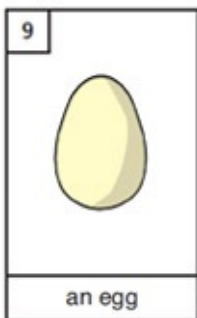



# The Bensons

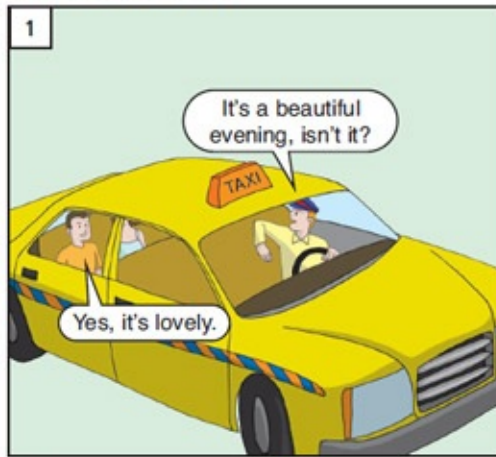

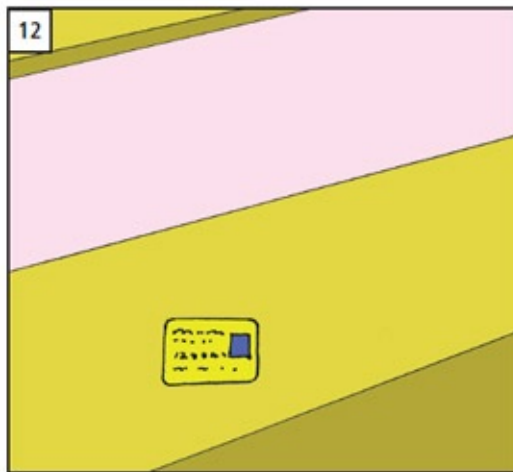
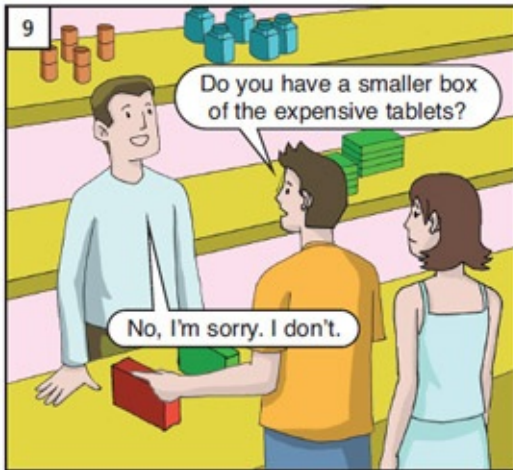
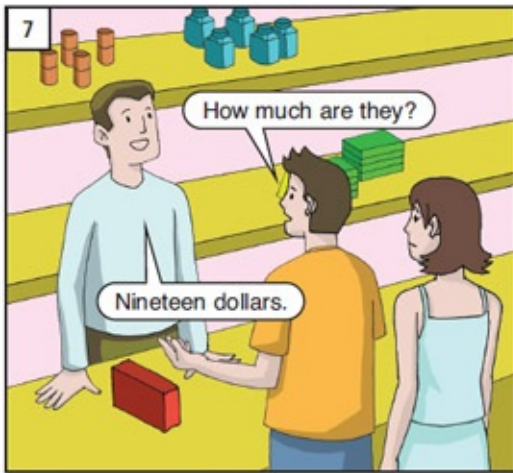

## UNIT 14: It's the second street on the left.

**left** [left]  
**right** [raɪt]  
**straight ahead** [streɪt əhedʹ]  
**turn** [tɜːrn]

**bank** [bæŋk]  
**bus stop** [bæŋk]  
**cinema** [bɪnə stɑːp]  
**car park** [sɪn'əmpɑː]  
**taxi rank** [tæksɪː ræŋk]  
**post office** [pəʊst ɔːfɪs]  
**gas station** [gæs steɪ'ʃən]  
**railway station** [reɪl'weɪ steɪ'ʃən]  
**supermarket** [suːpəːrmaːrkiːt]  
**stadium** [steɪ'diːəm]  
**traffic lights** [træf'ɪk laɪts]  
**toilet** [tɔɪ'liːt]

**red** [red]  
**yellow** [jel'əʊː]  
**blue** [bluː]  
**green** [riːn]  
**white** [waɪt]  
**black** [blæk]  
**orange** [ɔːr'ɪndʒ]  
**brown** [braʊn]

**before** [bɪfɔːrʹ]  
**past** [pæst]  
**with** [wɪθ]

**first** [fɜːrst]  
**second** [sek'ənd]  
**third** [θɜːrd]  
**fourth** [fɔːrθ]  
**fifth** [fɪfθ]  
**sixth** [sɪksθ]  
**seventh** [sev'ənθ]  
**eighth** [eɪtθ]  
**ninth** [naɪnθ]  
**tenth** [tenθ]

**fence** [fens]

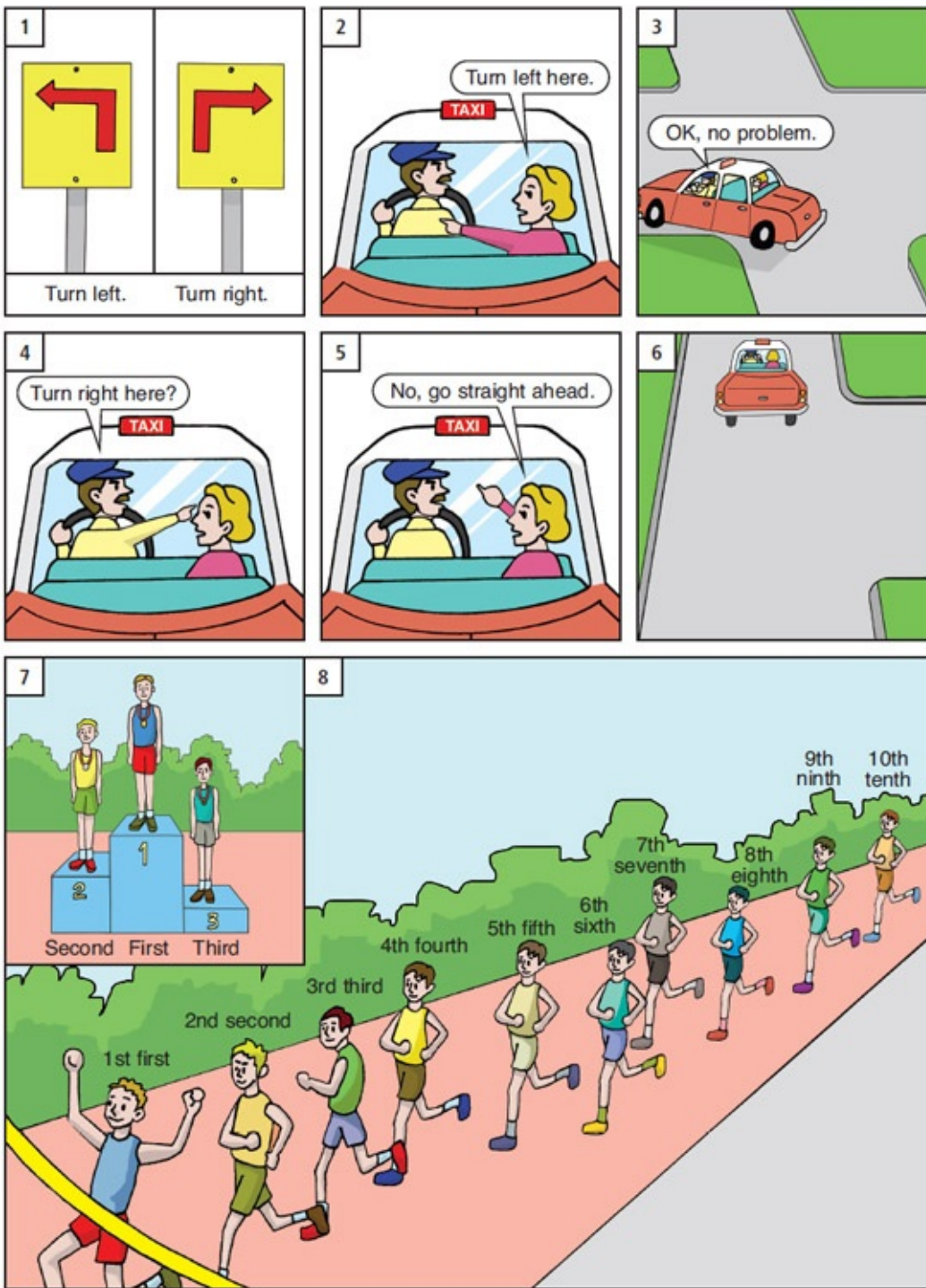

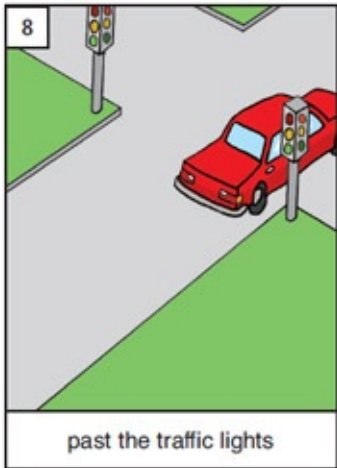
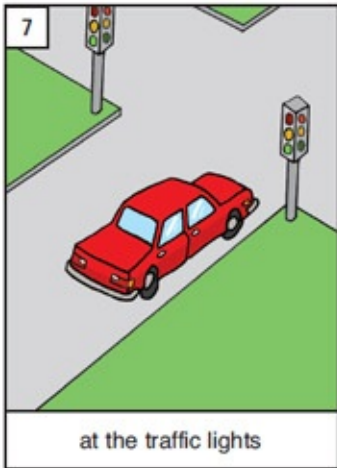
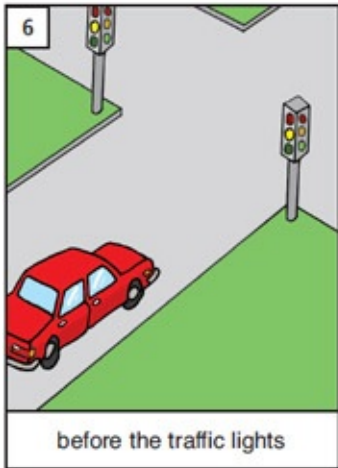
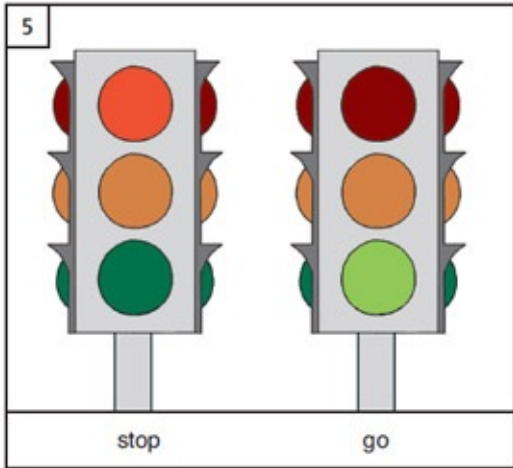
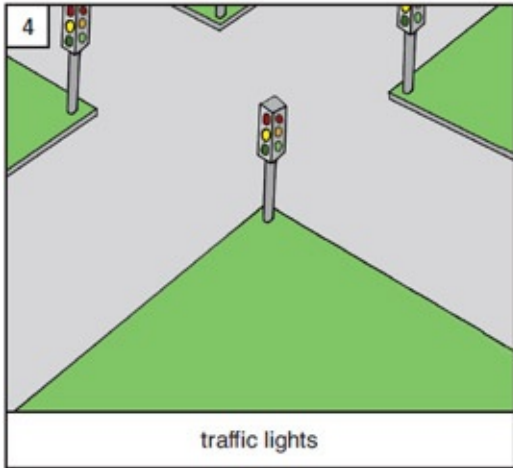
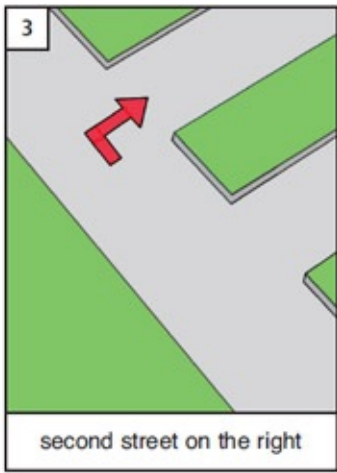
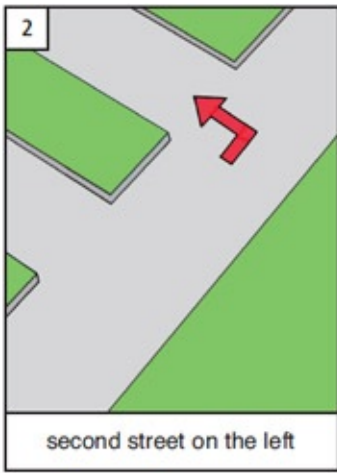
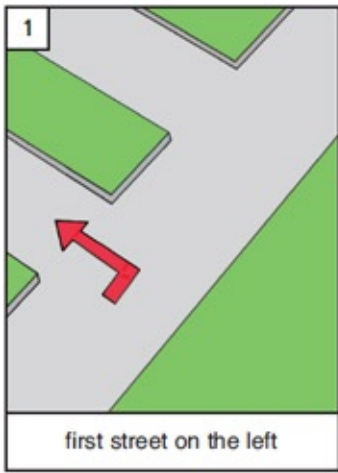

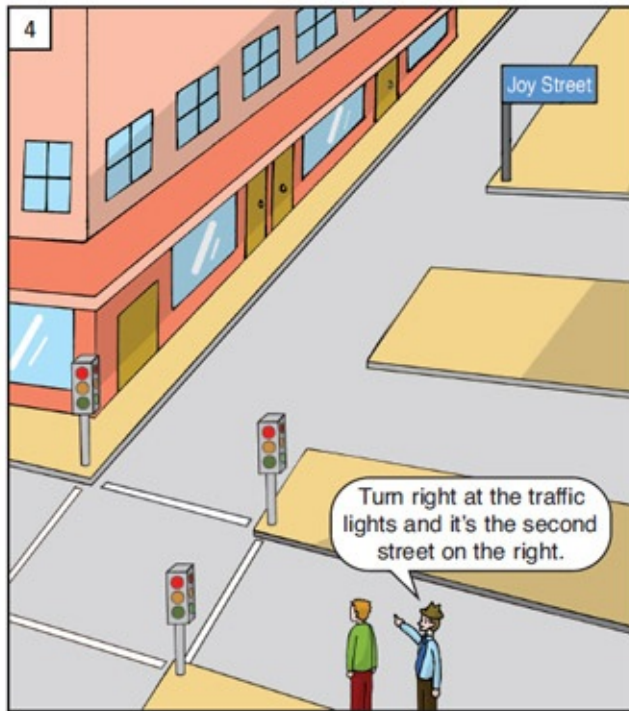
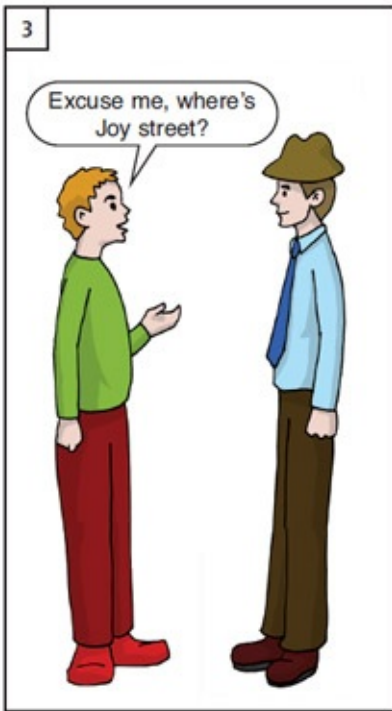
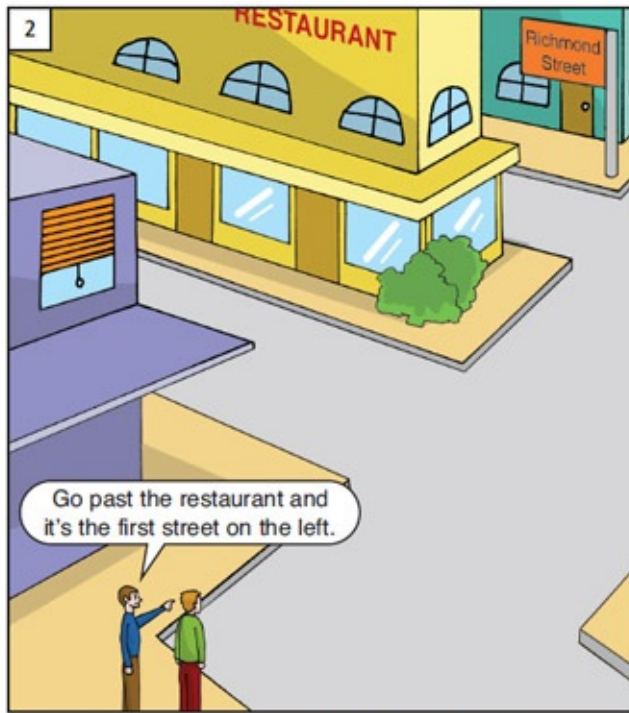
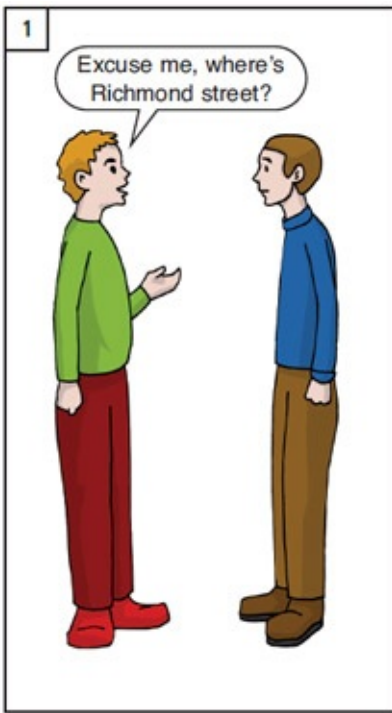

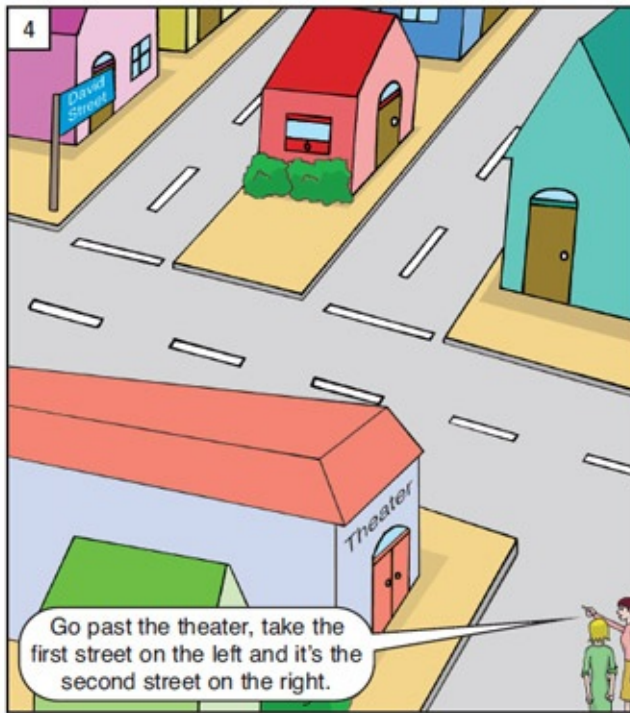
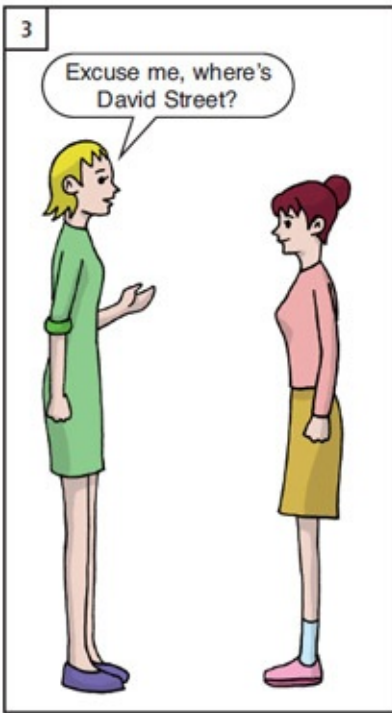
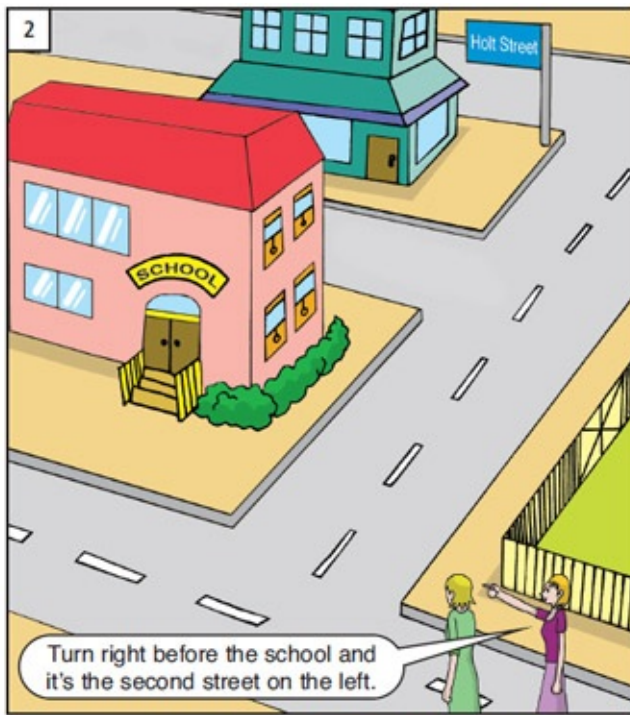
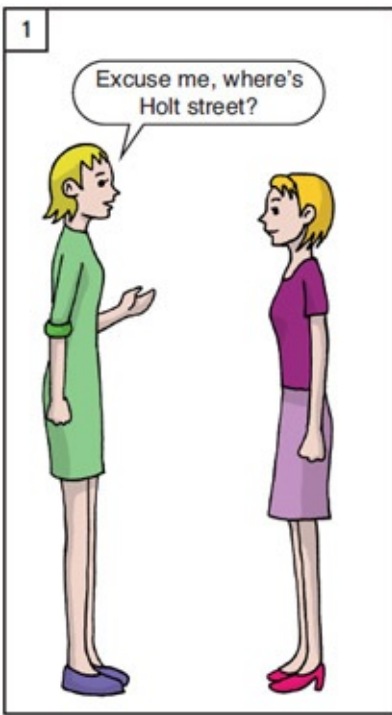

Excuse me, where's the...?

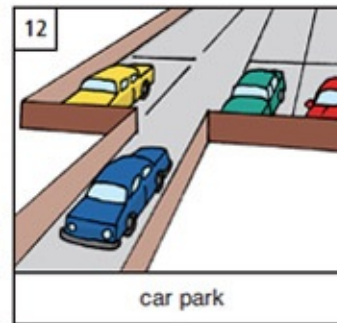
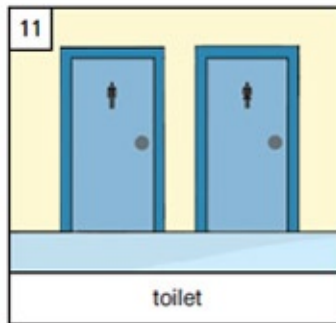
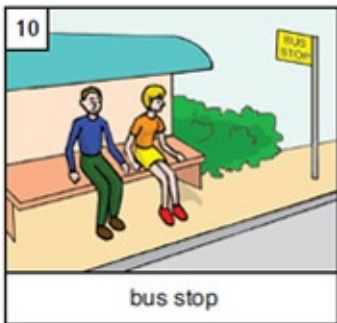
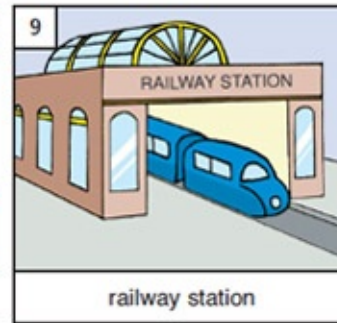
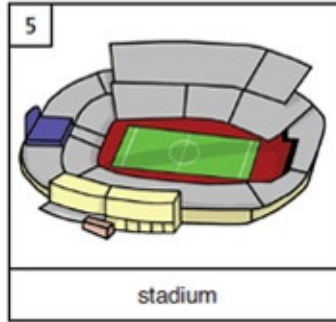
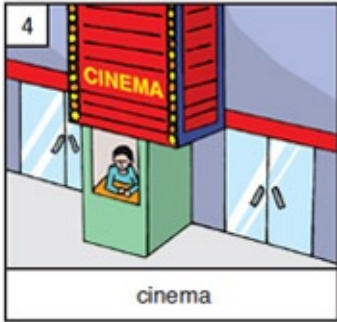
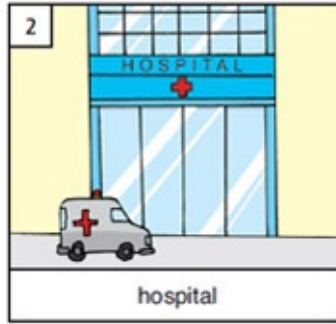
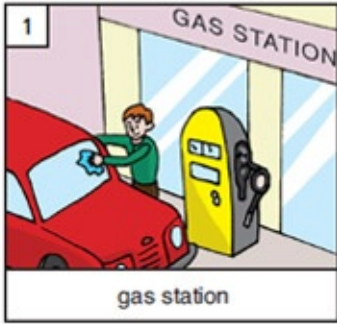



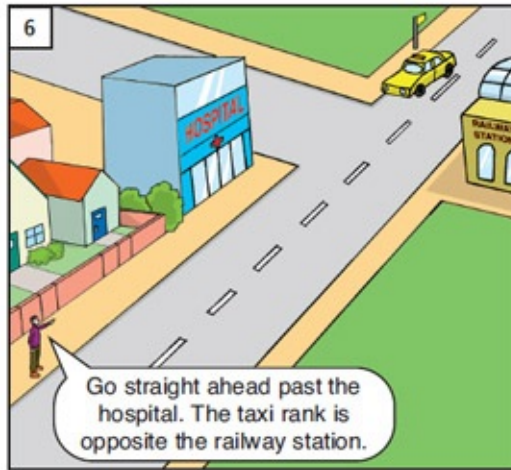
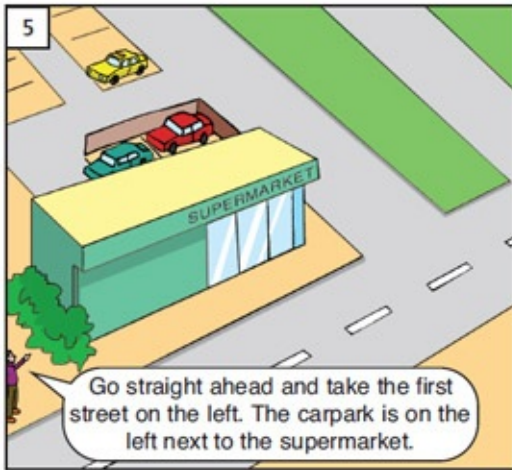
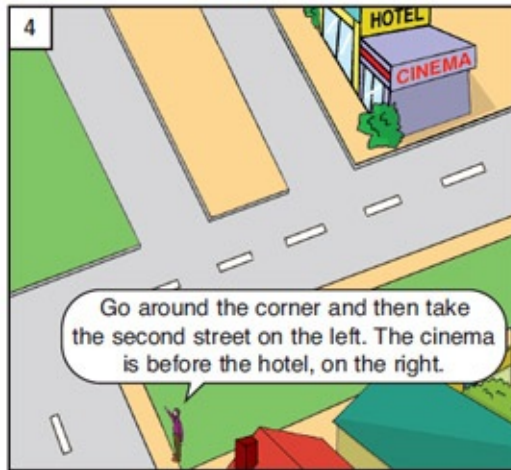
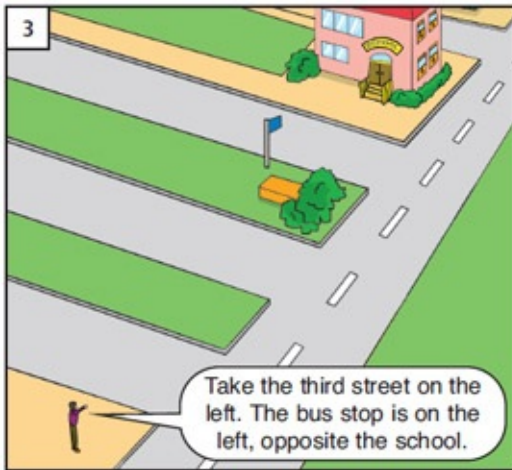
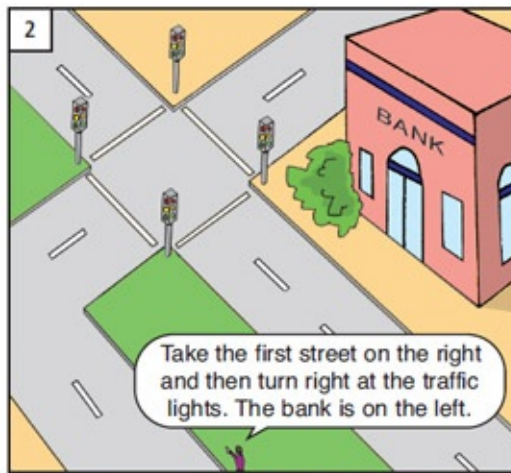
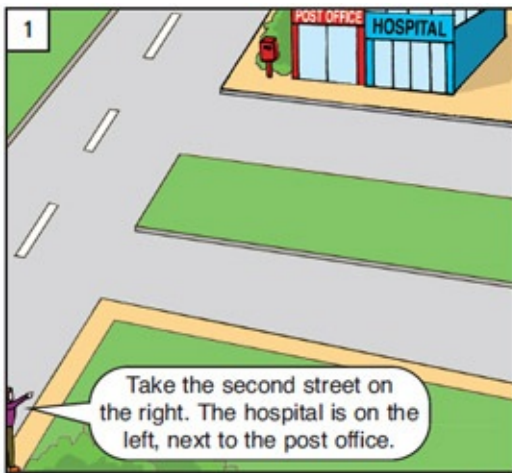

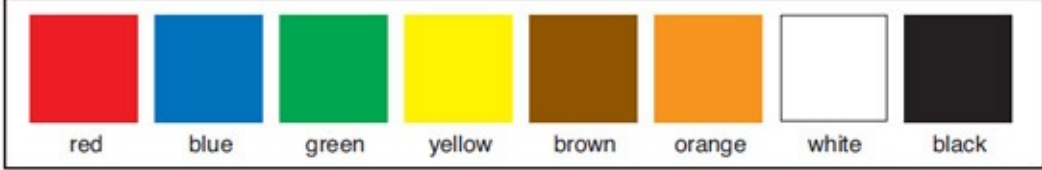

1

a red car

2

two red cars

3

a white car

4

two white cars

5

a red and white car

6

two red and white cars

7

a house

8

a roof

9

a fence

10

a white house with a red roof

11

a yellow house with a blue roof and a green fence

12

a .....

13





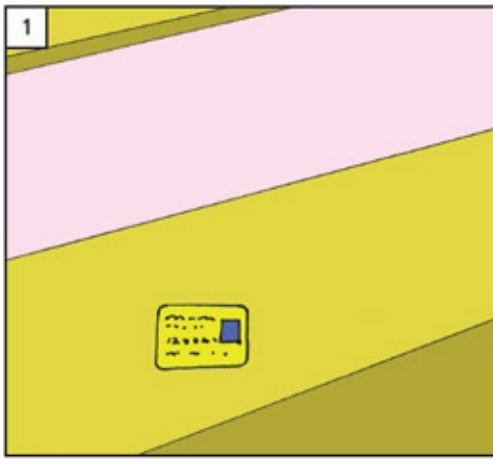











a .....

# The Bensons





# UNIT 15: Revision and extension

<p>1</p>  <p>hand</p> <p>.....</p>	<p>2</p>  <p>.....</p>	<p>3</p>  <p>.....</p>	<p>4</p>  <p>.....</p>
<p>5</p>  <p>.....</p>	<p>6</p>  <p>.....</p>	<p>7</p>  <p>.....</p>	<p>8</p>  <p>.....</p>
<p>9</p>  <p>.....</p>	<p>10</p>  <p>.....</p>	<p>11</p>  <p>.....</p>	<p>12</p>  <p>.....</p>
<p>13</p>  <p>.....</p>	<p>14</p>  <p>.....</p>	<p>15</p>  <p>.....</p>	<p>16</p>  <p>.....</p>

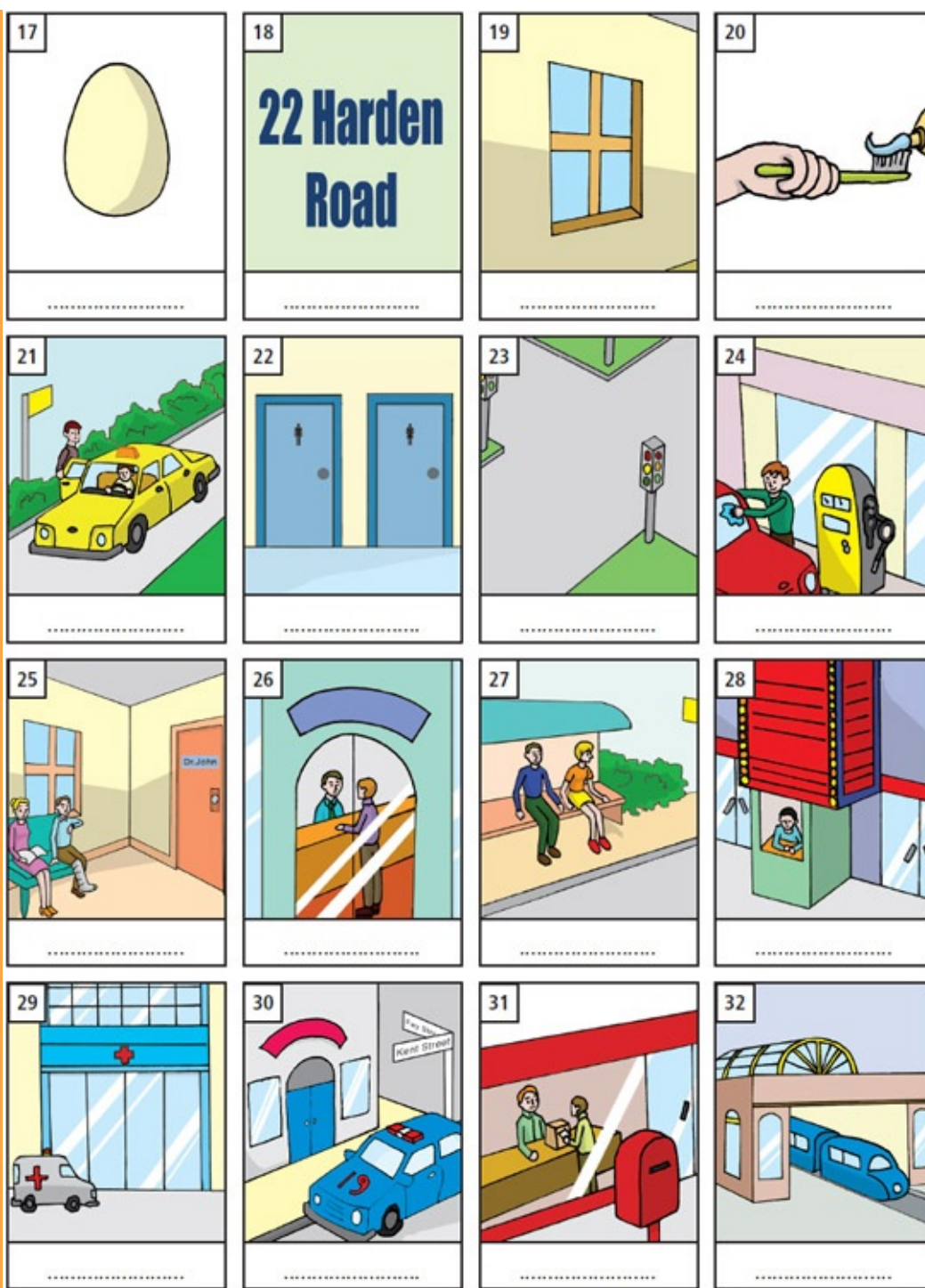

**A**

1. Good morning.
2. What's the matter?
3. I have a headache.
4. How's your headache?
5. Where do you live?
6. What's your address?

- a. At 2 Richmond Street.
- b. Better, thanks.
- c. Good morning.
- d. It's 2 Richmond Street.
- e. I have a headache.
- f. I'm sorry to hear that.

**B**

1. How's your headache now?

- a. It's ten dollars.

2. How much is this?
3. How much are they?
4. Cash or credit?
5. Are you all right?
6. Where's the hospital?

- b. My arm hurts
- c. Credit, please.
- d. It's straight ahead on the left.
- e. They're five dollars.
- f. Much better, thanks.

## C

1. Do we have any apples?
2. Do you play the violin?
3. Do I need a ticket?
4. Does she have any cash?
5. Does he play the trumpet?
6. Do they have a new car?

- a. Yes, she does.
- b. Yes, we do.
- c. No, they don't.
- d. Yes, he does.
- e. No, I don't.
- f. Yes, you do.





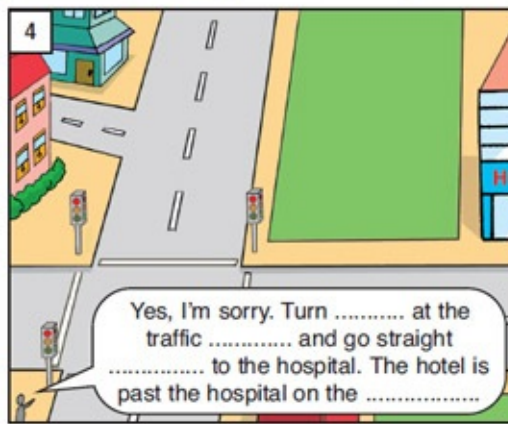
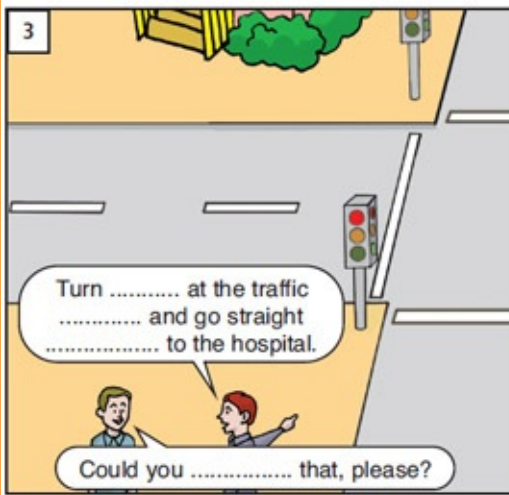
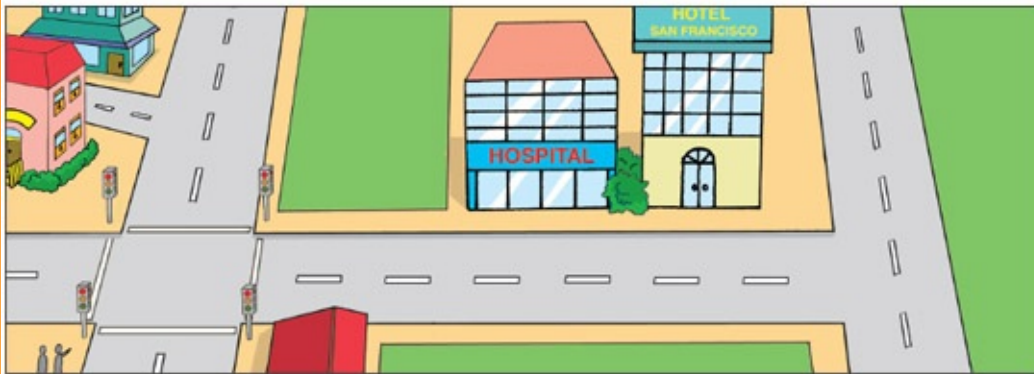

look

take

next

much

Where

like

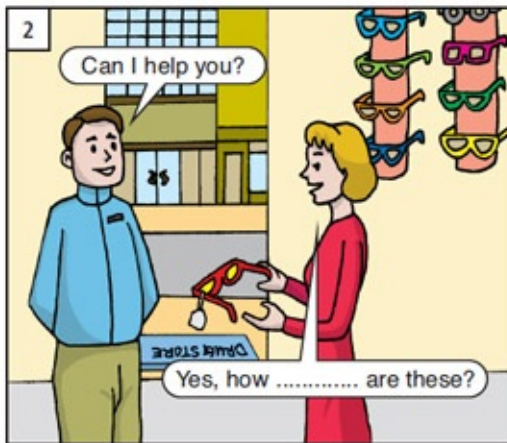





- > wrong What's
- > shoulder hurts My.



- > matter the What's
- > headache a have I



- > I to go now have
- > a What pity



- > you do Where live
- > 41 Wik Street live I at

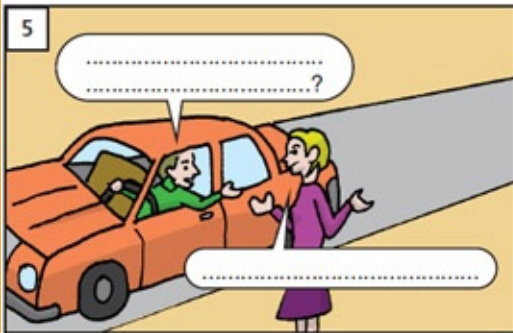

- > me the car where's park Excuse
- > Sorry know don't I



- > bank the Where's
- > corner It's the around



- > ticket need a You
- > much How it is



- > I you help Can
- > these How Yes much shoes are



- > now your tooth How's
- > thanks Better



- > take Do Visa you
- > Sure

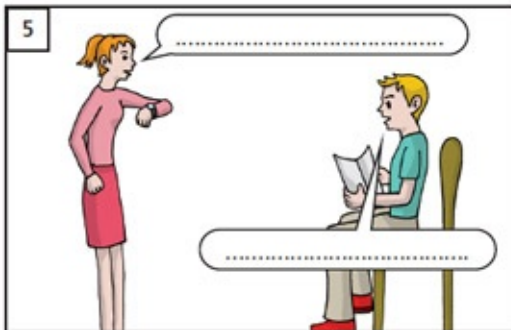

- > go We now to have
- > taxi a I'll call

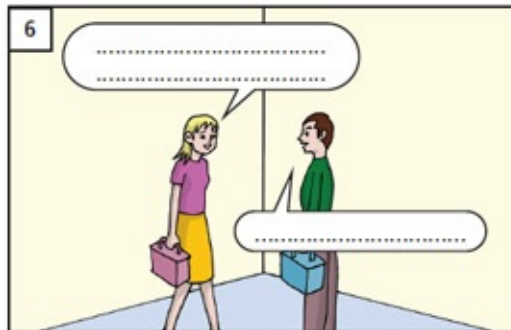

- > you me waiting for for Thank
- > OK That's

## UNIT 15: Answers

Unit 15, page 132

1. hand
2. back
3. ear

4. foot
  5. head
  6. knee
  7. leg
  8. shoulder
  9. stomach
  10. arm
  11. tooth
  12. sun
  13. moon
  14. stars
  15. cash
  16. credit card
- 

Unit 15, page [133](#)

17. egg
  18. address
  19. window
  20. toothbrush
  21. taxi rank
  22. toilet
  23. traffic lights
  24. gas station
  25. waiting room
  26. bank
  27. bus stop
  28. cinema
  29. hospital
  30. police station
  31. post office
  32. railway station
- 

Unit 15, page [134](#)

- A. 1c 2e 3f 4b 5a 6d  
B. 1f 2a 3e 4c 5b 6d

Unit 15, page 135

2. how, have
  3. Since
  4. hurt
  5. take, for, evening 6. at, chemist
- 

Unit 15, page 136

1. help
  3. left, lights, ahead, repeat 4. left, lights, ahead, right
- 

Unit 15, page 137

1. Where
  2. much
  3. look
  4. next
  5. take
  6. like
- 

Unit 15, page 138

1. right, My
  3. I'll
  4. live, with
  5. for
  6. How's
- 

Unit 15, page 139

1. What's wrong?  
My shoulder hurts.
2. What's the matter?  
I have a headache.
3. I have to go now.

**What a pity.**

**4. Where do you live?**

**I live at 41 Wik Street.**

**5. Excuse me, where's the car park?**

**Sorry, I don't know.**

**6. Where's the bank?**

**It's around the corner.**

---

**Unit 15, page 140**

**1. You need a ticket.**

**How much is it?**

**2. Can I help you?**

**Yes. How much are these shoes?**

**3. How's your tooth now?**

**Better, thanks.**

**4. Do you take Visa?**

**Sure.**

**5. We have to go now.**

**I'll call a taxi.**

**6. Thank you for waiting for me.**

**That's OK.**



## UNIT 16: She bought a cake.

**wash** [wɒʃ]

**pull** [pʊl]

**push** [pʊʃ]

**open** [ou'pən]

**close** [ou'pəʊn]

**talk** [tɔ:k]

**was** [wʌz]

**were** [wə:r]

**write** [raɪt]

**sleep** [sli:p]

**buy** [baɪ]

**sell** [sel]

**drive** [draɪv]

**eat** [i:t]

**teach** [ti:tʃ]

**Mum** [ma:m]

**clean** [kli:n]

**dirty** **dirty** [dɜ:r'ti:]

 it will = it'll

 he will = he'll

 she will = she'll

turn  
play  
call  
work  
arrive  
agree  
wait  
stop

turning  
playing  
calling  
working  
arriving  
agreeing  
waiting  
stopping

turned  
played  
called  
worked  
arrived  
agreed  
waited  
stopped

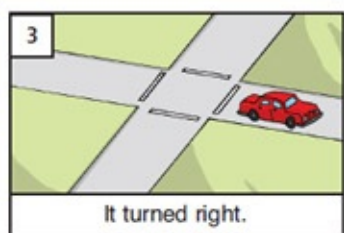

wash  
open  
close  
pull  
push  
talk

washing  
opening  
closing  
pulling  
pushing  
talking

washed  
opened  
closed  
pulled  
pushed  
talked



1 He's washing the car.



2 He's opening the door.



3 He's closing the door.



4 They're pulling the car.



5 They're pushing the car.

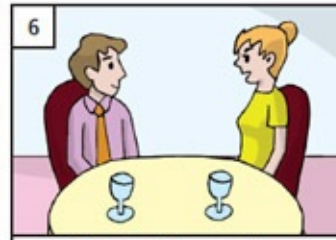

6 She's talking to him.



7 He'll pull the suitcase.



8 He's ..... the suitcase.



9 He pulled the suitcase.



10 ..... his hands.



11 He's washing his hands.



12 He ..... his hands.



13 She'll close the window.



14 ..... the window.



15 .....the window.



they will = they'll

run  
eat  
bring  
come  
go  
take  
do  
meet  
have  
leave  
think  
pay  
hurt  
get  
make  
teach

running  
eating  
bringing  
coming  
going  
taking  
doing  
meeting  
having  
leaving  
thinking  
paying  
hurting  
getting  
making  
teaching

ran  
ate  
brought  
came  
went  
took  
did  
met  
had  
left  
thought  
paid  
hurt  
got  
made  
taught

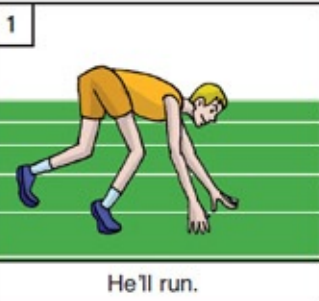

He'll run.

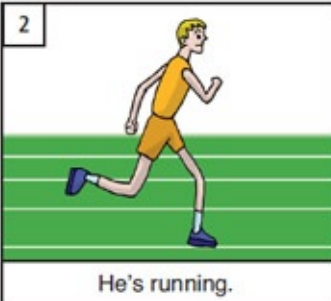

He's running.

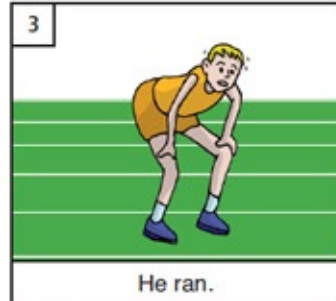

He ran.

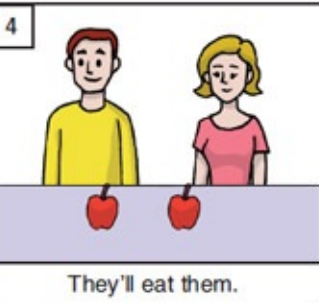

They'll eat them.

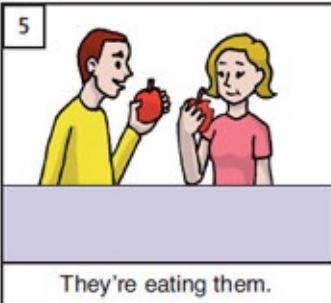

They're eating them.

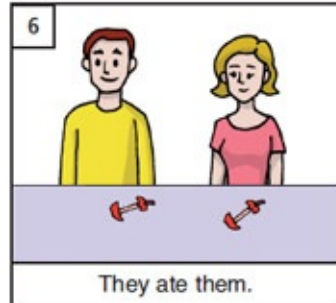

They ate them.

sleep  
write  
buy  
sell  
drive

sleeping  
writing  
buying  
selling  
driving

slept  
wrote  
bought  
sold  
drove



1

He's sleeping.

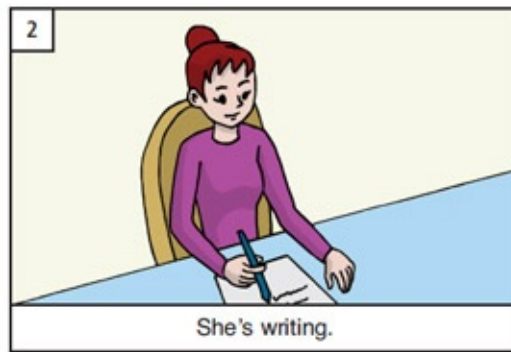

2

She's writing.



3

She's buying a ticket. He's selling a ticket.



4

He's driving a car.



5

He'll sleep.



6

He's sleeping.

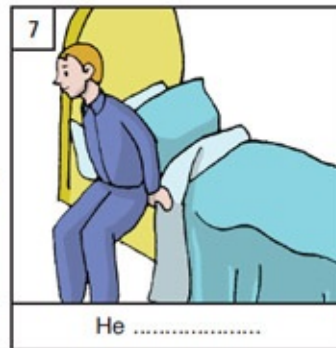

7

He .....



8

She'll teach them.



9

..... them.



10

She ..... them.

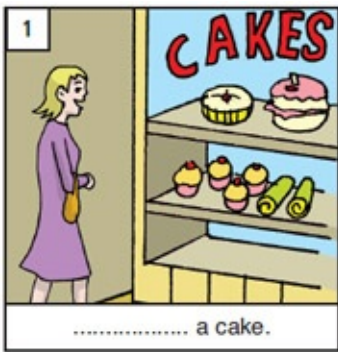

<p>I am You are He is She is It is We are They are</p>	<p>I was You were He was She was It was We were They were</p>
--	---

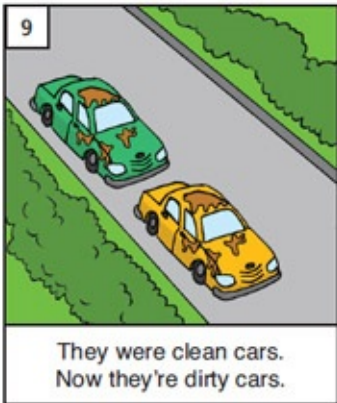
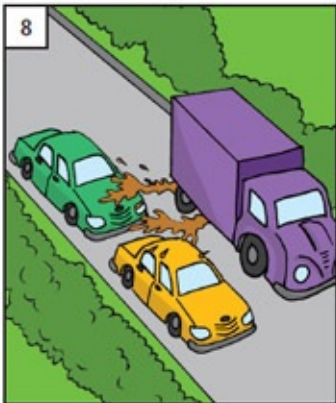
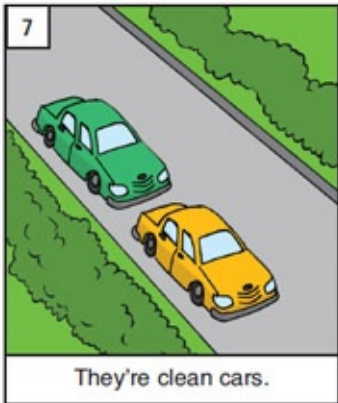
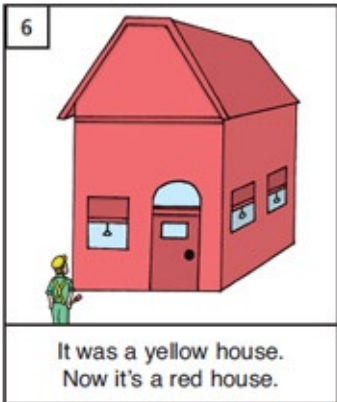
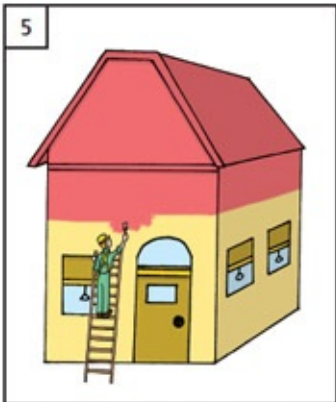
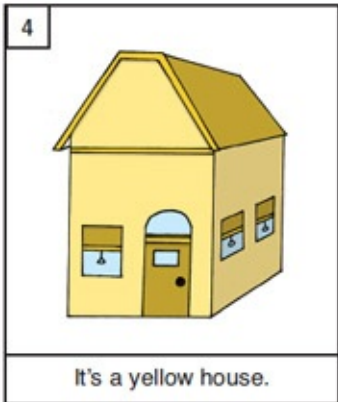

# The Bensons

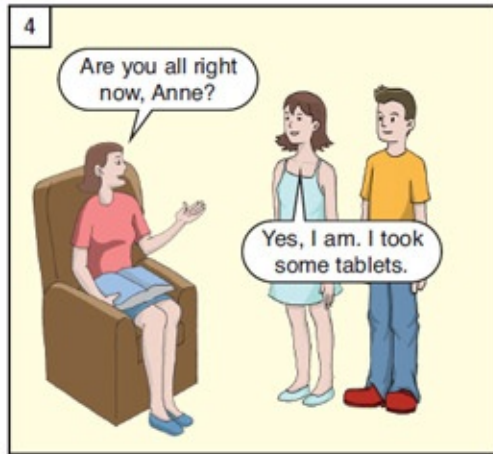
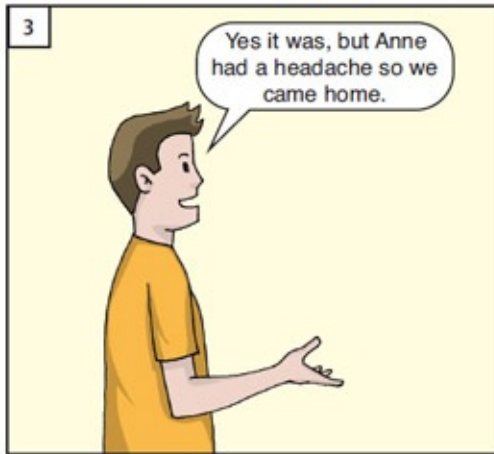

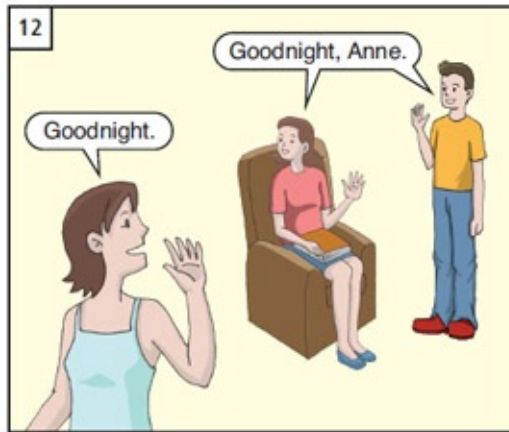
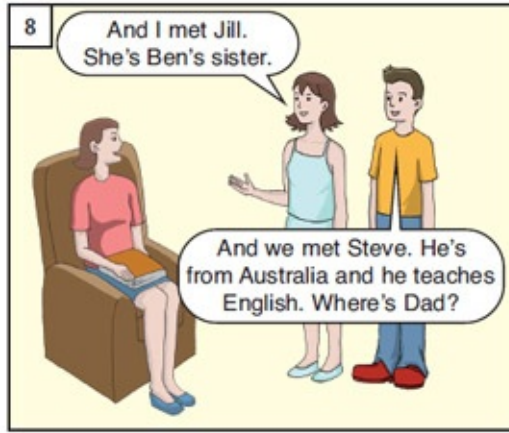



## UNIT 17: They're working in the garden.

read [ri:d]  
watch [wɑ:tʃ]  
work [wɜ:rk]  
swim [swim]  
shop [ʃɑ:p]  
drink [drɪŋk]

play [pleɪ]  
chess [tʃes]  
football [fʊt'bɔ:l]  
golf [gɔ:lf]  
tennis [ten'ɪs]

hair [he:r]  
have a haircut [hæv ə he:r'kʌt]

busy [bɪzi:]  
please [pli:z]

after [æf'tɜ:r]  
before [bɪfɔ:r]

breakfast [brek'fæst]  
lunch [lʌntʃ]  
dinner [dɪn'ə:r]

newspaper [nu:z'peɪpə:r]  
television [tel'ɪvɪʒən]  
garden [gɑ:rdən]

telephone (phone) [tel'əfəʊn]  
I'll get it. [aɪl et ɪt]  
speak [spi:k]  
Who's calling? [hu:z kɔ:lɪŋ]  
ask [æsk]  
message [mes'ɪdʒ]  
leave a message [li:v ə mes'ɪdʒ]  
take a message [teɪk ə mes'ɪdʒ]  
number [num'bɜ:r]  
beep [bi:p]

long [lɔ:ŋ]

short [ʃɔ:rt]

full [fʊl]

empty [em'pti:]

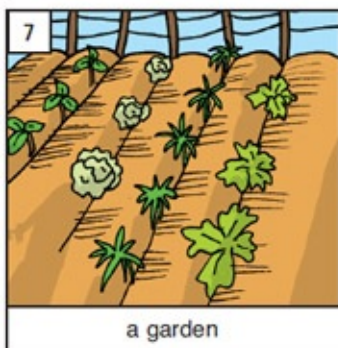
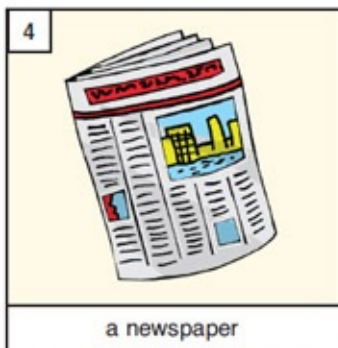
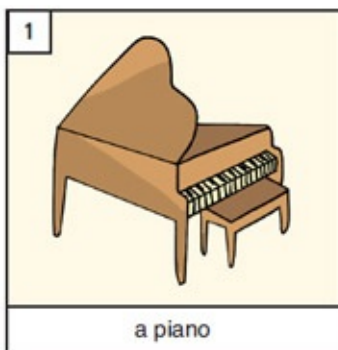

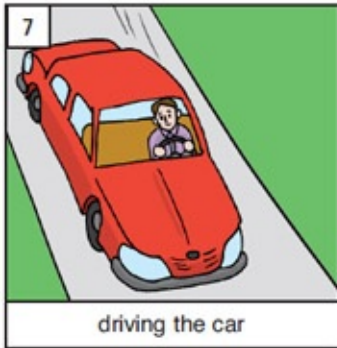
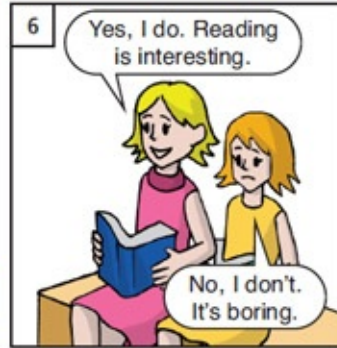
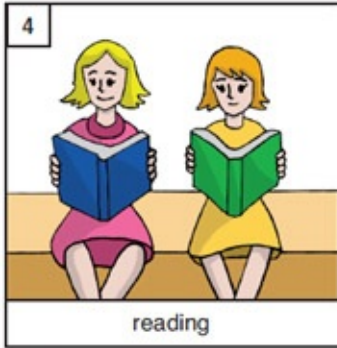
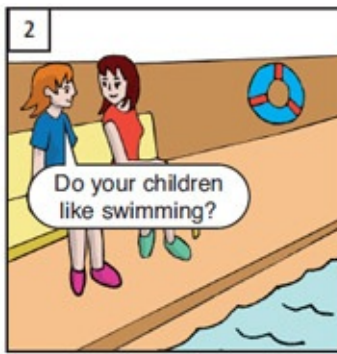
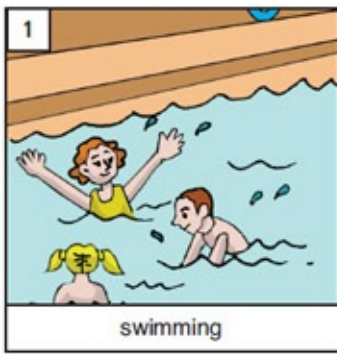

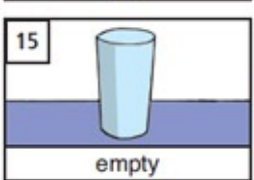
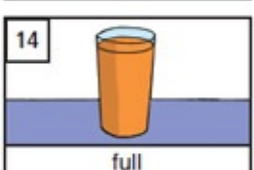
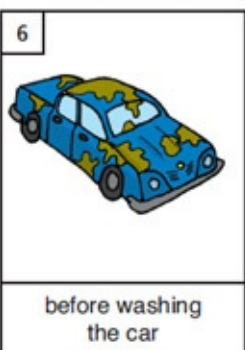
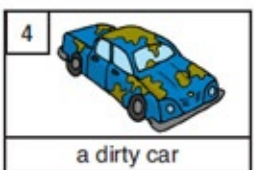
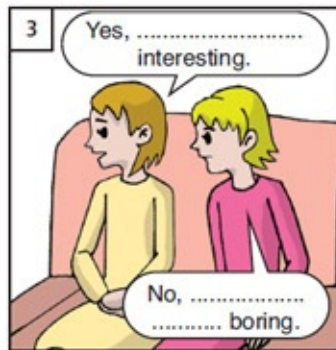
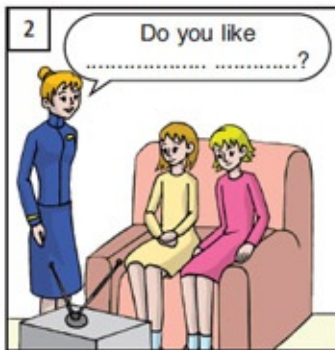
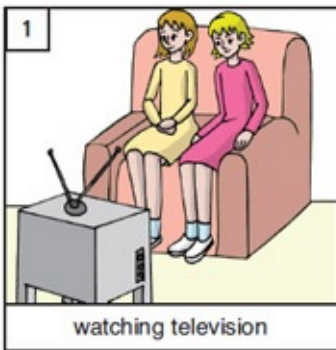

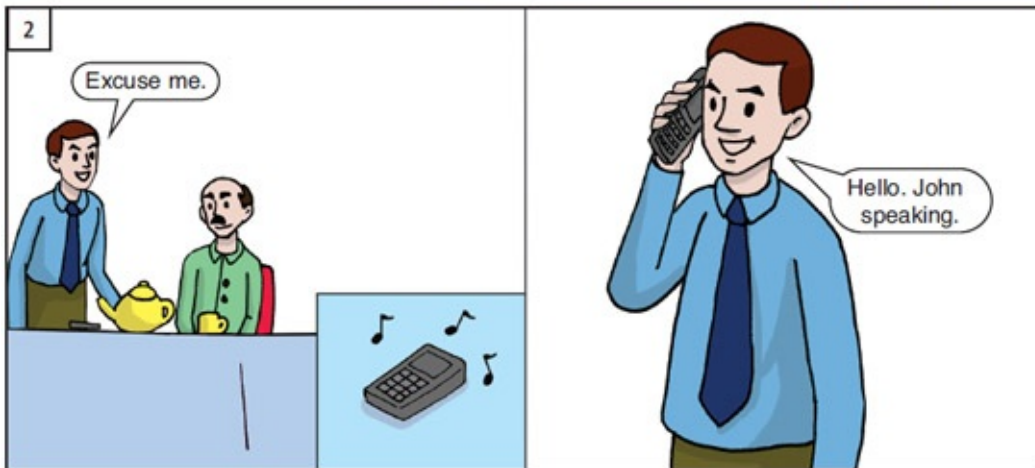



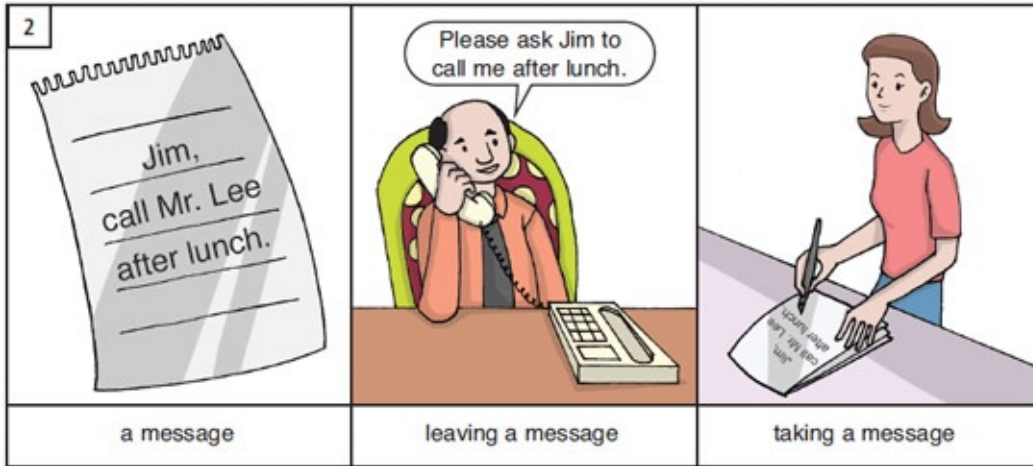







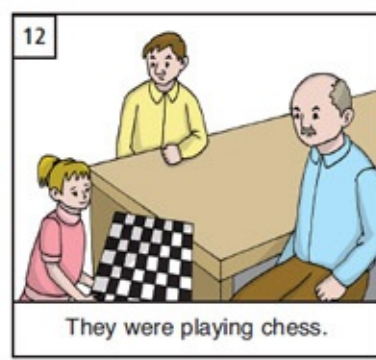
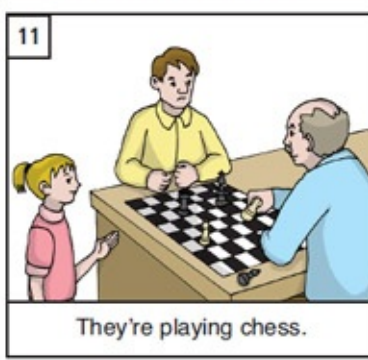
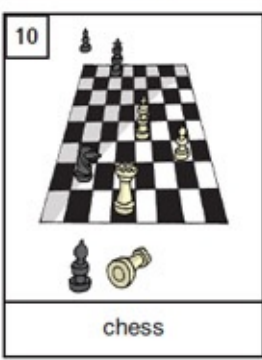
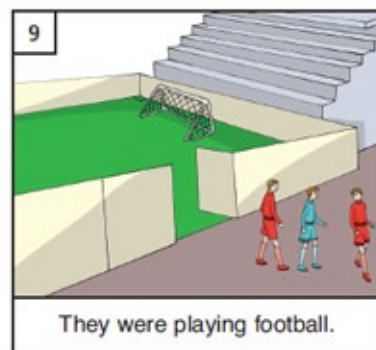
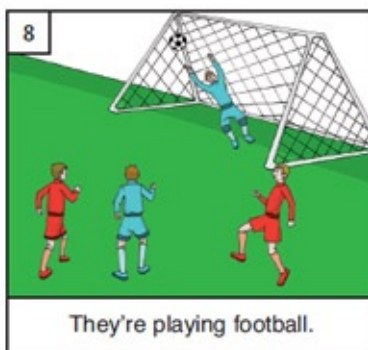
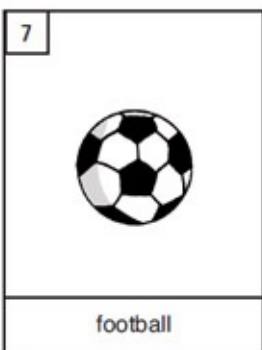
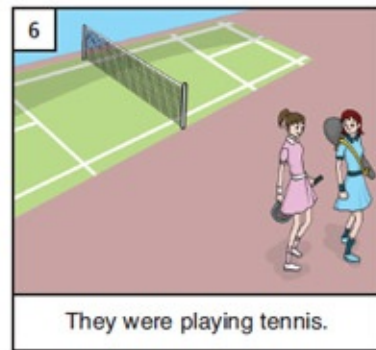
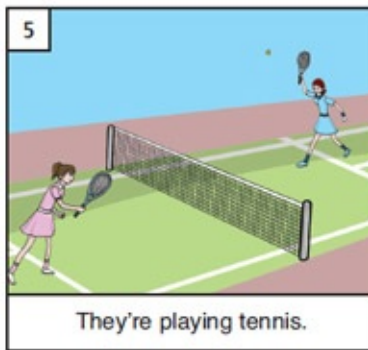
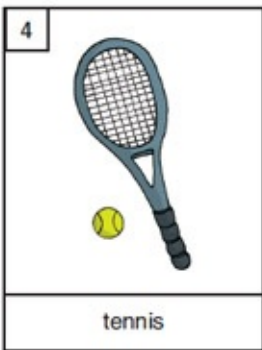
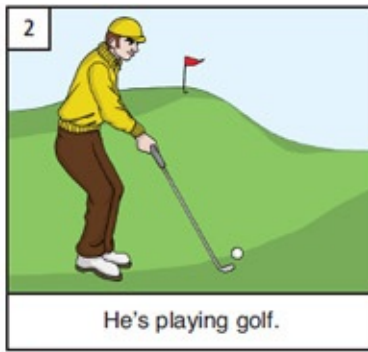
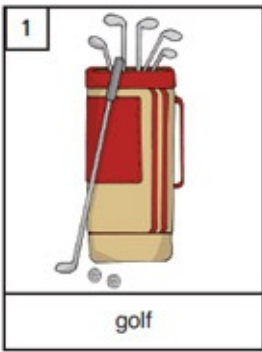

# The Bensons





## UNIT 18: What's the time?

Can you tell me the time, please? [kæn ju: tel mi: ðə taim pli:z]

What's the time? [wɒtɪz ðə taim]

clock [kla:k]

quarter [kwɔ:r'tə:r]

half [hæf]

o'clock [əkla:k]

a quarter past [ə kwɔ:r'tə:r pæst]

half past [hæf pæst]

a quarter to [ə kwɔ:r'tə:r tu:]

a.m. [ei em]

p.m. [pi: em]

yesterday [jes'tə:deɪ]

today [tədeɪ]

tomorrow [təmə'rəʊ]

appointment [əpɔɪnt'mənt]

flight [flaɪt]

wedding [wed'ɪŋ]

angry [æŋ'ɡri:]

happy [hæp'i:]

sad [sæd]

worried [wə'ri:d]

welcome [wel'kəm]

early [ə'rli:]

late [leɪt]

1

some clocks

2

one o'clock

3

two o'clock

4

three o'clock

5

one o'clock

6

two o'clock

7

three o'clock

8

a watch

9

What's the time, please?

It's two o'clock.

10

one fifteen

11

one thirty

12

one forty-five

13

a quarter

14

a quarter past one

15

a quarter past nine

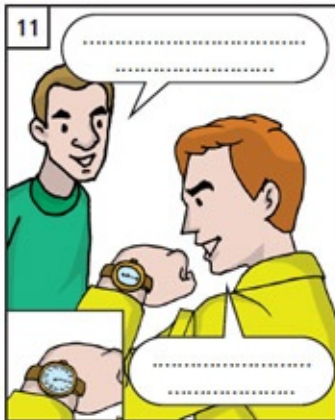
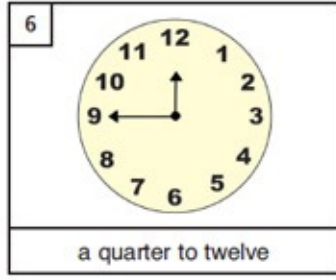
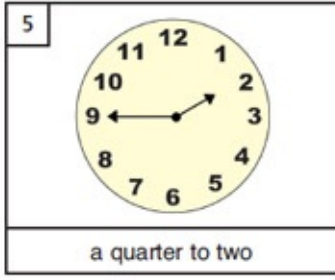
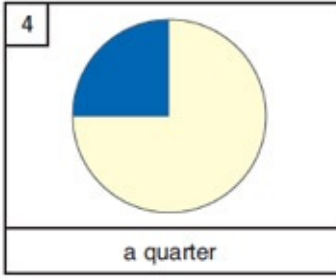
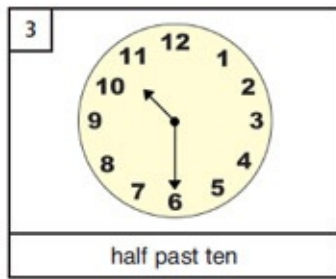
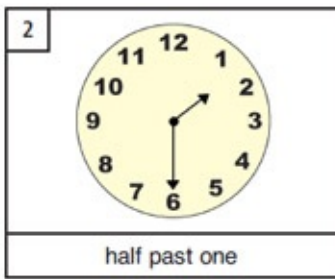
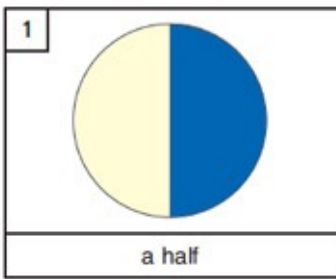



when is = when's





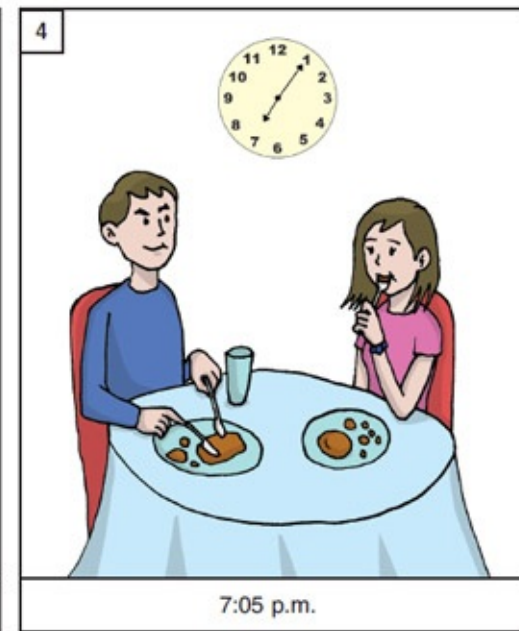
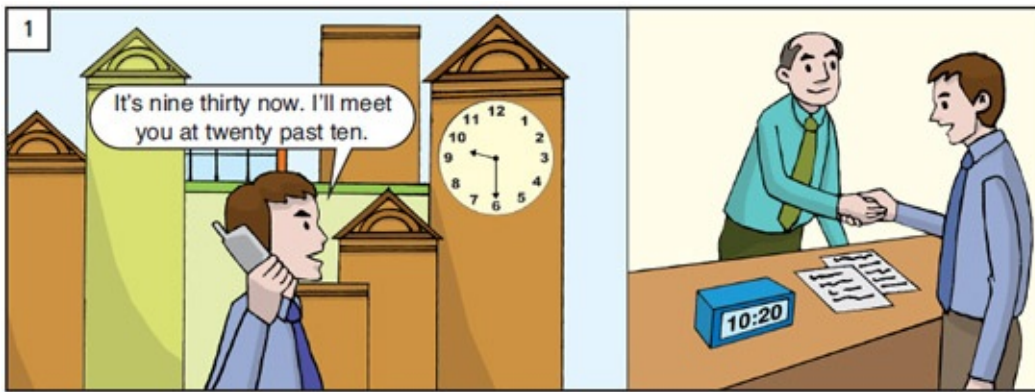



a wedding



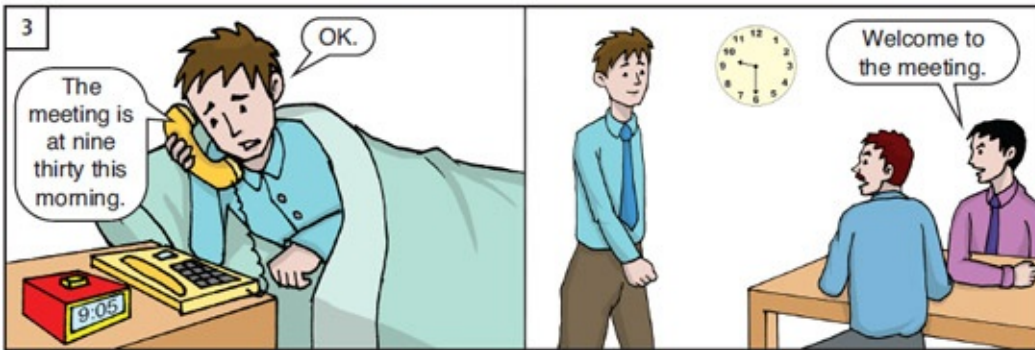

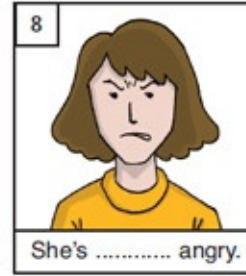
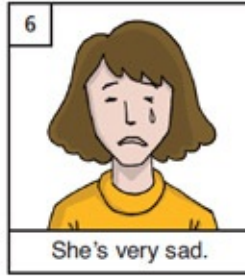
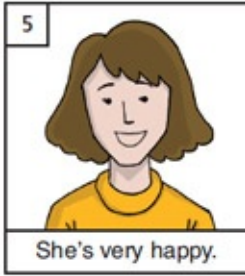
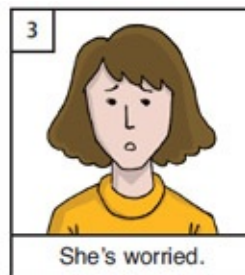
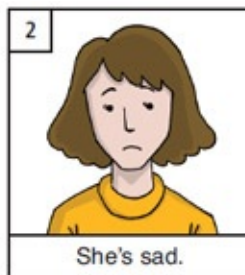
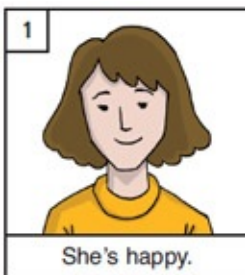

# The Bensons

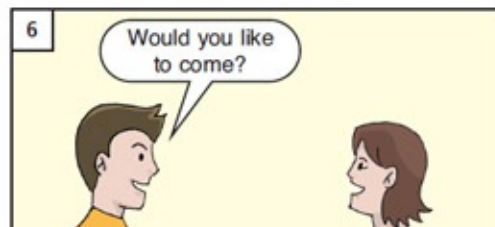
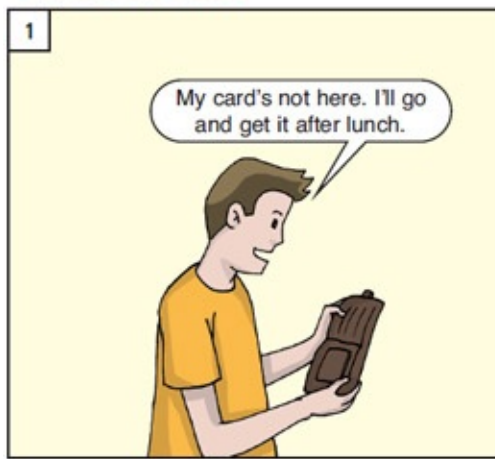

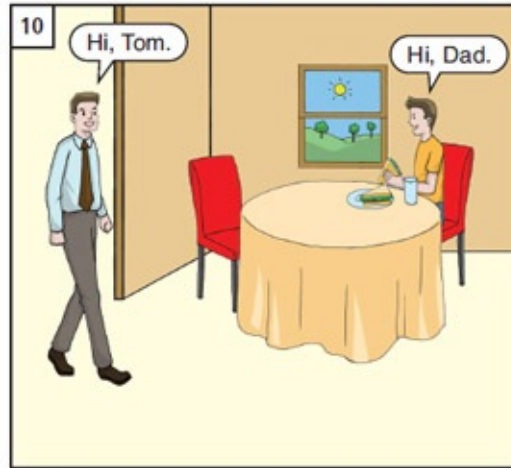
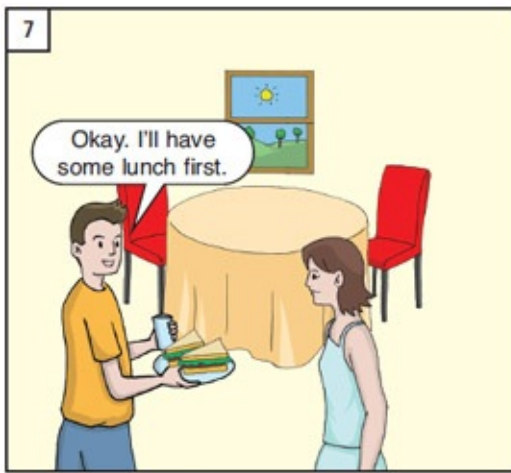

## UNIT 19: You're not allowed to park here.

Does this bus go to... ? [dʌz ðis bʌs ɡoʊ tu:]

Can you tell me when to get off [kæn ju: tel mi: wen tu: get ɔ:f]

How long... ? [haʊ lɔ:ŋ]

timetable [taɪm'teɪbəl]

heat [hi:t]

miss [mɪs]

use [ju:z]

park [pɑ:rk]

heated [hi:t'ɪd]

missed [mɪst]

used [ju:zd]

parked [pɑ: rkt]

bicycle [baɪ'sɪkəl]

ferry [fer'i:]

tram [træm]

second [sek'ənd]

minute [mɪn'ɪt]

hour [aʊə:r]

You're not allowed to... [ju:r na:t əlaʊd tu:]

No parking [nəʊ pɑ:rkɪŋ]

get off [get ɔ:f]

get on [et ɔ:n]

change [tʃeɪndʒ]

Here you are. [hɪr ju: a:r]

1



a bus

2

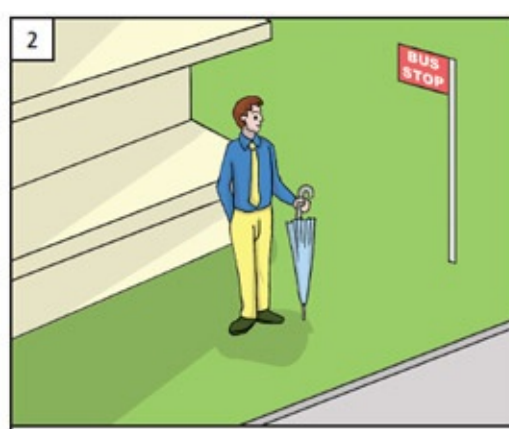

He's waiting for the bus.

3



He's getting on the bus.

4

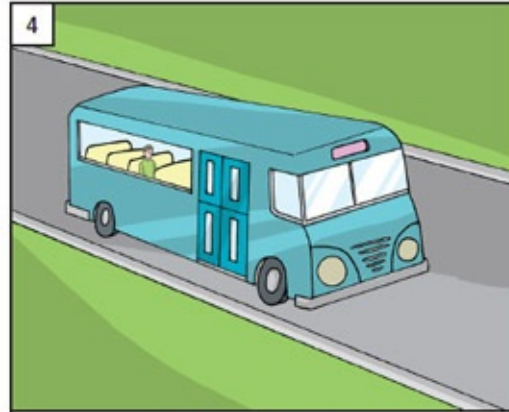

He's going by bus.

5

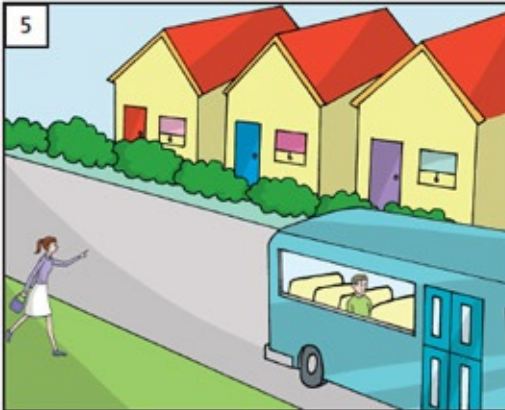

She missed the bus.

6

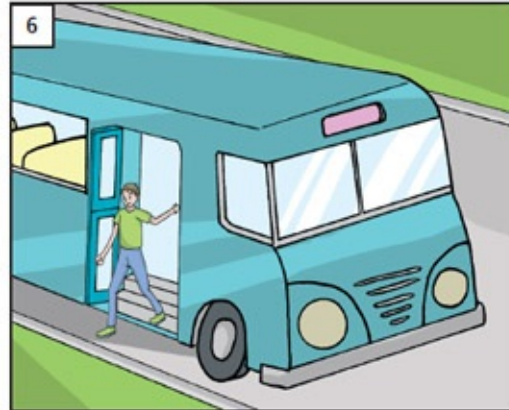

He's getting off the bus.



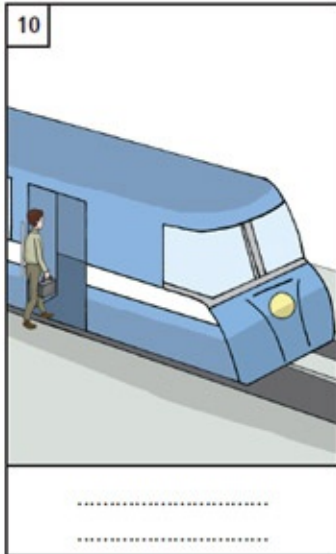
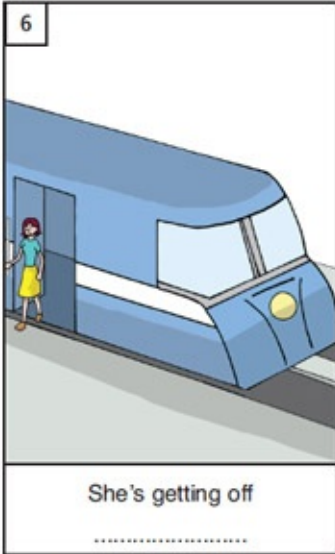
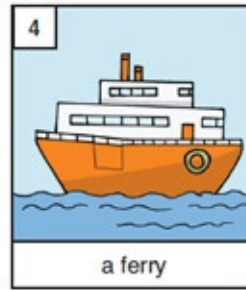
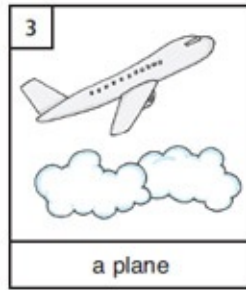
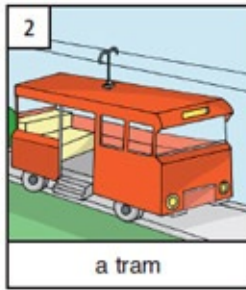
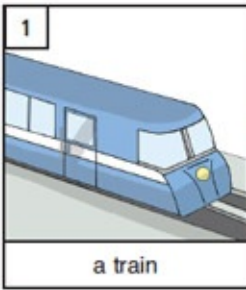

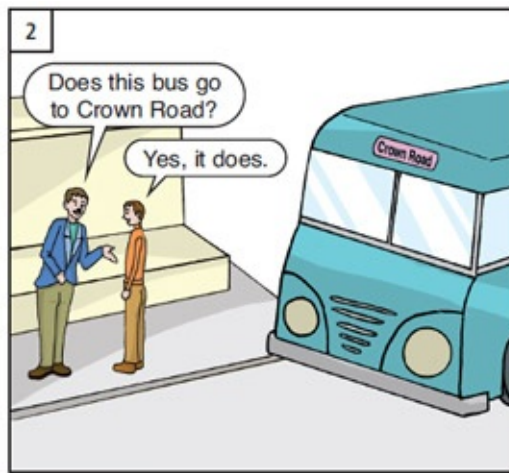
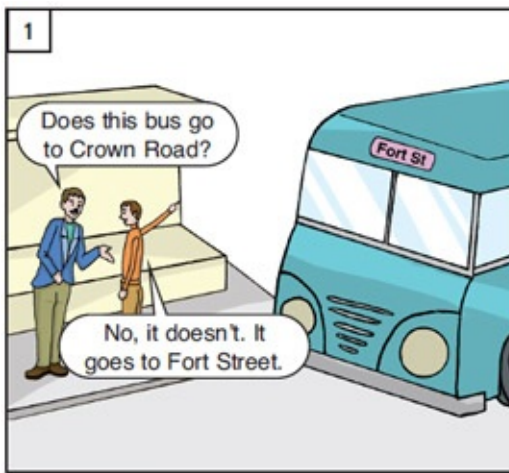

1

1:00      2:00

one hour

2

The meeting is in one hour.

3

How long will it take?

Two hours.

4

2:00      2:30

half an hour

5

2:30      2:45

quarter of an hour

6

DEPARTURES  
4:30 NEW YORK

When does the plane for New York leave?

In half an hour.

7

2:45      2:46

one minute

8

The shop opens in three minutes.

OPEN 9:00 A.M.

9

2:46:01      2:46:02

one second

10

Heat for 20 seconds

20 seconds

1

How many hours in one day?

Twenty four.

2

How many minutes in one hour?

Sixty.

3

How many seconds in one minute?

Sixty.

4

How many days in one week?

Seven.

5

How many weeks in one year?

Fifty two.

6

How many months in one year?

Twelve.

7

TRAIN  
TIMETABLE

MON  
TUES  
WED  
THURS  
FRI  
SAT  
SUN

a timetable

8

Do you have a timetable, please?

Sure, here you are.

Thanks.

9

When's the next train to Hawthorn?

TRAINS TO HAWTHORN	ARRIVAL AT HAWTHORN
9:02	9:27
9:15	9:40

In ten minutes.

10

How long will it take to get there?

TRAINS TO HAWTHORN	ARRIVAL AT HAWTHORN
9:02	9:27
9:15	9:40

Twenty five minutes.



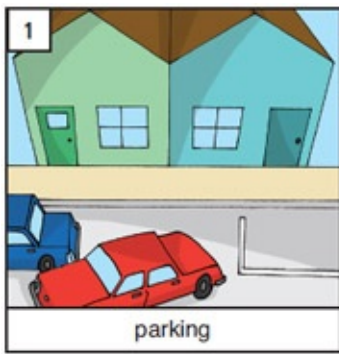

# The Bensons

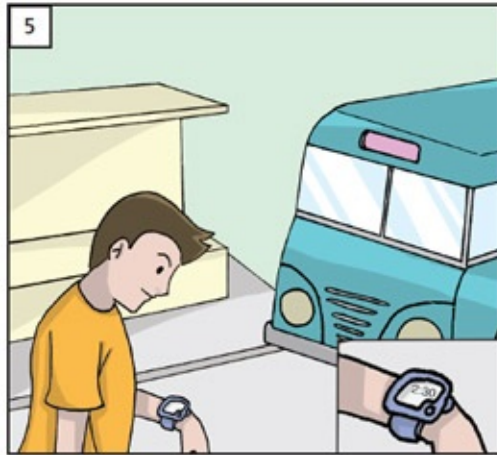
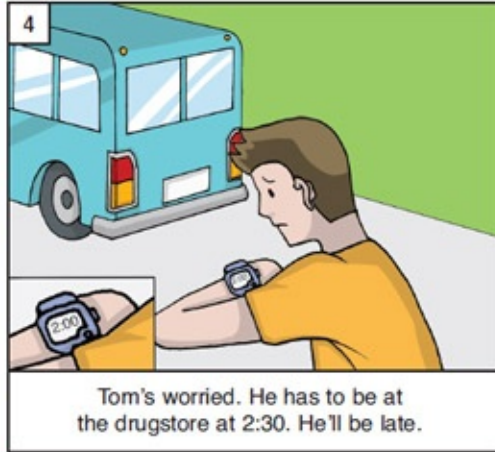
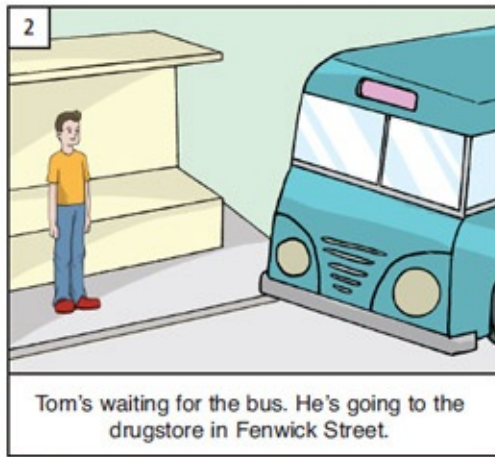

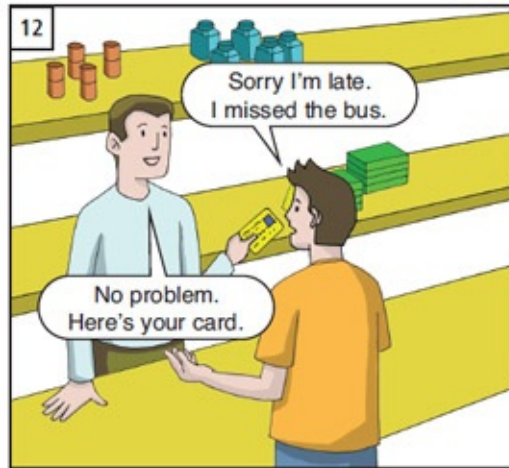
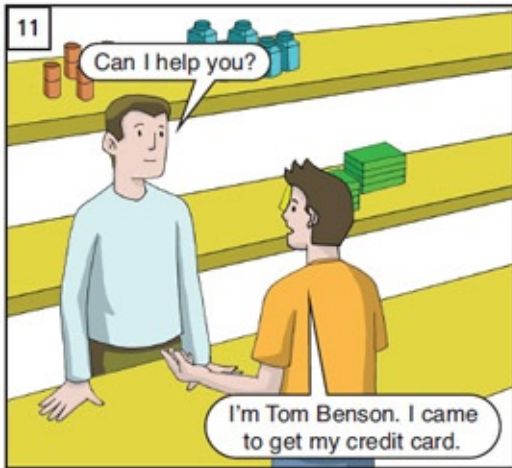



# UNIT 20: Revision and extension

1  bicycle .....	2  .....	3  .....	4  .....
5  .....	6  .....	7  .....	8  .....
9  .....	10  .....	11  .....	12  .....
13  .....	14  .....	15  .....	16  .....
17  .....	18  .....	19  .....	20  .....

**A**

1. Can I speak to Sue, please?

2. Who's calling?

3. Can I take a message?

4. What's your number?

a. It's 874298.

b. Sorry, she's busy. Can I take a message?

c. This is Peter.

d. Ask her to call me after lunch, please.

**B**

1. What's the time?
  2. When's the appointment?
  3. When was the meeting?
  4. You're not allowed to park here.
- a. Tomorrow at two o'clock.
  - b. Yesterday at two o'clock.
  - c. It's two o'clock.
  - d. Sorry. I didn't know.

**C**

1. Does this bus go to Crown road?
  2. When's the next train?
  3. How much to Richmond street?
  4. Have you got a timetable?
- a. Three dollars twenty.
  - b. Sure, here you are.
  - c. At half past four.
  - d. Yes, it does.

**D**

1. Does she like playing the piano?
  2. Do you like watching television?
  3. Does he like playing football?
  4. Do they like shopping?
- a. No, he doesn't.
  - b. Yes, they do.
  - c. No, she doesn't.
  - d. Yes, I do.

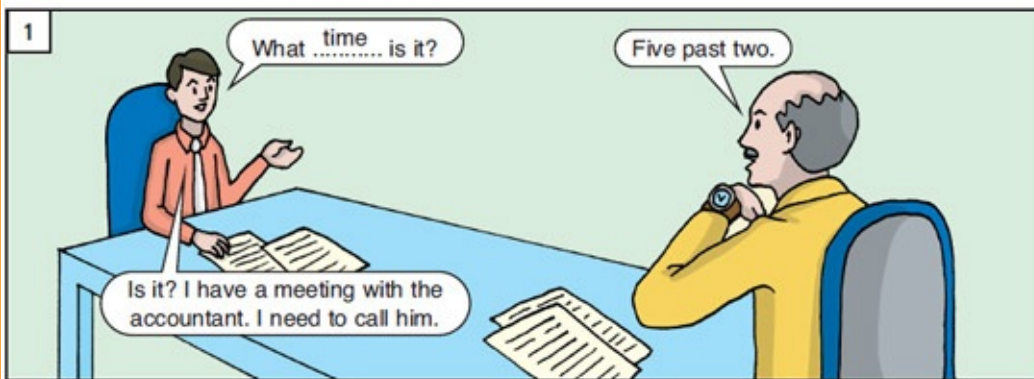

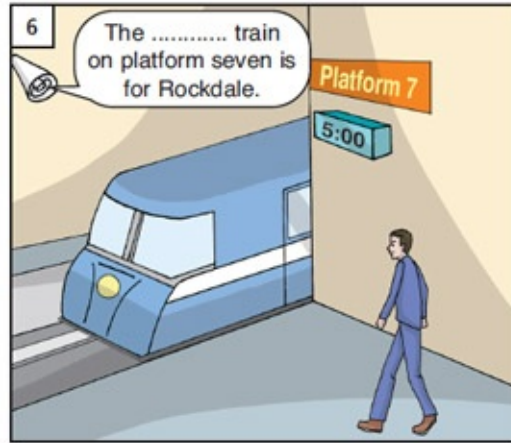
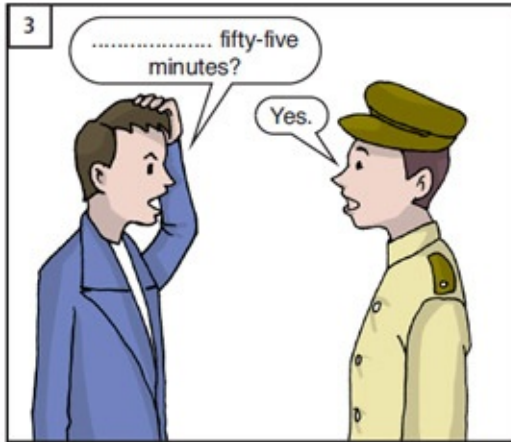

1

You went to Australia last year, ..... you?



Yes, ..... three weeks. It was great.

2

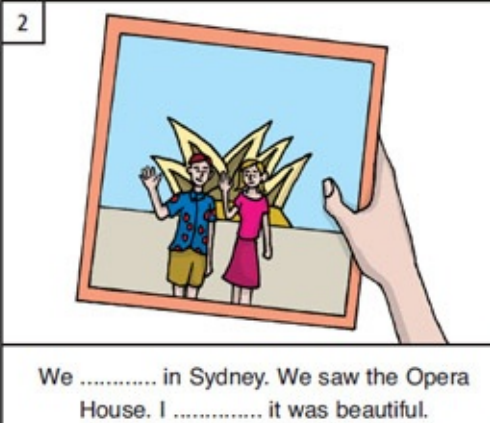

We ..... in Sydney. We saw the Opera House. I ..... it was beautiful.

3



We ..... to the beach in the afternoons.

4

How was the hotel?



Great. We ..... it very much.

5



We ..... at the hotel restaurant every night.

6

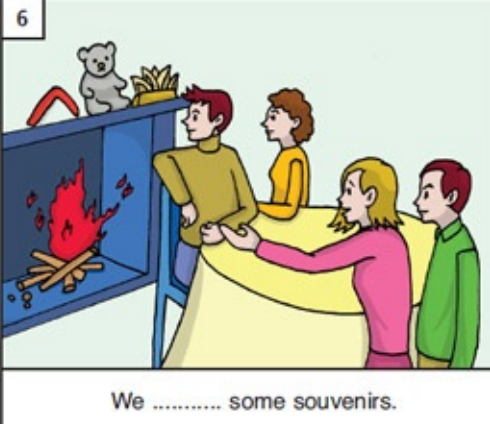

We ..... some souvenirs.

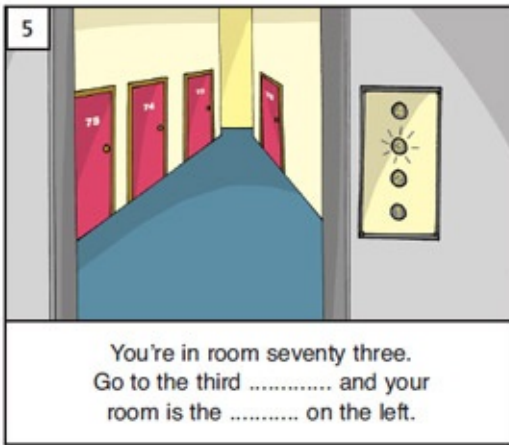



- > I speak John Can to
- > him get I'll Sure.



- > the What's time
- > a seven to It's quarter



- > is the to next When Rockdale train
- > thirty eleven At five



- > open restaurant does When the
- > this quarter a seven past evening At



- > meeting the When's
- > nine morning past At tomorrow half



- > arrive When plane the does
- > past At half afternoon this two



- > bus go Crown Road this Does to
- > does Yes it



- > this Queenscliff to go Does train
- > doesn't No it



- > to much Kingsfield How it is
- > dollars three It's



- > running like you Do
- > don't I No



- > driving like you Do
- > I Yes do



- > allowed You are not park here to
- > know I Sorry didn't

## UNIT 20: Answers

Unit 20, page 182

1. bicycle
2. tram
3. breakfast
4. lunch



5. dinner
  6. timetable
  7. football
  8. golf
  9. tennis
  10. message
  11. newspaper
  12. chess
  13. telephone
  14. television
  15. wedding
  16. clock
  17. happy
  18. angry
  19. worried
  20. sad
- 

Unit 20, page **183**

- A. 1b 2c 3d 4a
  - B. 1c 2a 3b 4d
  - C. 1d 2c 3a 4b
  - D. 1c 2d 3a 4b
- 

Unit 20, page **184**

1. time
  2. leave, message, ten, past, late 3. I'll
  4. speaking
  5. meet
- 

Unit 20, page **185**

2. At
3. In
4. earlier
5. late, wait
6. next

---

Unit 20, page 186

1. didn't, for
  2. stayed, thought
  3. went
  4. liked
  5. ate
  6. bought
- 

Unit 20, page 187

1. room
  2. names
  3. like
  4. watching
  5. floor, third
  6. key, open
- 

Unit 20, page 188

1. Can I speak to John?  
Sure, I'll get him.
  2. What's the time?  
It's a quarter to seven.
  3. When's the next train to Rockdale?  
At eleven thirty five.
  4. When does the restaurant open?  
At a quarter past seven this evening.
  5. When is the meeting?  
At half past nine tomorrow morning.
  6. When does the plane arrive?  
At half past two this afternoon.
- 

Unit 20, page 189

**1. Does this bus go to Crown Road? Yes, it does.**

**2. Does this train go to Queenscliff?**

**No, it doesn't.**

**3. How much is it to Kingsfield?**

**It's three dollars.**

**4. Do you like running?**

**No, I don't.**

**5. Do you like driving?**

**Yes, I do.**

**6. You are not allowed to park here.**

**Sorry, I didn't know.**

# Index

a	1
a pair of	6
a.m.	18
accountant	3
address	12
after	17
afternoon	11
agree	9
am	2
angry	18
any	13
apple	6
application form	7
appointment	18
April	8
are	2
Are you all right?	11
aren't	4
arm	11
around the corner	12
arrive	8
art gallery	2
ask	17
at	12
August	8
baby	4
back	11
backache	11
bad	9
bag	6
banana	6
bank	14

basketball player	9
beach	2
beans	9
beautiful	4
beep	17
before	14, 17
big	9
bill	11
black	14
blue	14
book	1
boring	9
bottle of	6
box	13
bread	9
breakfast	17
bring	2
broccoli	9
brother	1
brown	14
burger	6
bus	8
bus stop	14
businessman	7
busy	17
but	2
buy	16
by	8
Bye	11
cabbage	9
cake	6
call	12
camera	1
can	2
Can I help you?	9
can of	6
Can you tell me the time please?	18
Can you tell me when to get off?	19
cap	9

car	1
car park	14
card	12
carrot	9
carton	13
cash	13
cauliflower	9
ceiling	13
cent	8
change	19
cheap	9
chess	17
child	6
chips	6
cinema	14
clean	16
clock	18
close	16
coffee	6
cold	4
colleague	3
come	2
concert	2
cookie	6
corner	127
Could you repeat that please?	7
credit card	13
cucumber	9
cup of	6
cute	4
Dad	11
daughter	1
day	4,8,11
December	8
did	7
dinner	2, 17
dirty	16
do	4

Do you have	13
Do you like	9
Do you take	13
doctor	7
does	4
Does this bus go to	19
doesn't	4
dollar	8
don't	4
door	2
drink	17
drive	16
drugstore	13
ear	11
earache	11
early	18
eat	16
egg	13
eight	6
eighteen	8
eighth	14
eighty	12
eleven	8
empty	17
enter	2
evening	11
everyone	8
Excuse me	1
exit	2
expensive	9
family	1
fast	4
father	1
February	8
fence	14
fifteen	8
fifth	14
fifty	12

first	14
fit	4
five	6
flight	18
floor	13
foot	11
football	17
for	8
forty	12
four	6
fourteen	8
fourth	14
Friday	8
friend	3
from	7
full	17
garden	17
gas station	14
get	12
get off	19
get on	19
glass of	6
go	2
go home	11
golf	17
good	4, 9
Good afternoon	11
Good evening	11
Good morning	11
Good night	11
Good to meet you	3
great	4
green	14
guitar	13
hair	17
half	18
hand	11
happy	18



have	7
have a haircut	17
Have a nice day	11
have to	11
Have you met	3
he	2
head	11
headache	11
heat	19
heavy	9
hello	7
her	1
here	3
Here you are	19
Hi	3
him	2
his	1
horse	9
hospital	12
hot	4
hour	19
house	1
how about	2
How did you get here?	8
How long	19
How long have you been here?	8
How many do you have?	7
How many?	6
How much	8
How's your now?	13
hurt	11
husband	1
I	2
I don't know	1
I live at	12
I'd like	3
I'd like you to meet	3
I'd love to but I can't	2

I'd love to	2
I'll	12
I'll get it	17
I'm a	7
I'm afraid I can't	2
I'm from	8
I'm sorry to hear that	11
I'm sorry	7
I've been here for	8
ice cream	9
in	2
interesting	9
is	1
isn't	1
it	1
it's	1
It's all right	4
January	8
jockey	9
juice	6
July	8
June	8
Keep right	11
key	1
knee	11
know	2
laptop	1
late	18
leave	8
leave a message	17
left	14
leg	11
let's	2
lettuce	9
light	9
like	9
long	17
looks good	4

looks like	3
lovely	4
lunch	2, 17
make	13
March	8
market	2
May	8
me	2
mechanic	7
meet	3
meeting	2
message	17
met	3
milk	6
mine	4
minute	19
miss	19
mobile phone	1
Mom	16
Monday	8
month	8
moon	11
morning	11
mother	1
movies	2
mushroom	9
my	1
My name's	1
name	1
narrow	9
near	12
need	13
neighbor	3
new	13
newspaper	17
next door	12
next to	12
night	11

nine	6
nineteen	8
ninety	12
ninth	14
no	1
No parking	19
No problem	13
No, I haven't	3
No, thanks	6
not	4
November	8
now	7
number	17
nurse	7
nuts	6
o'clock	18
occupation	7
October	8
OK	2
old	13
on	12
one	6
one hundred	12
onion	9
open	16
opposite	12
or	13
orange	6, 14
our	1
out	2
p m	18
pair of sunglasses	9
pants	9
park	19
party	2
past	14
pasta	9
pay	11

peach	6
pear	6
peas	9
pen	1
pharmacist	7
phone	17
piano	13
picnic	2
piece of	6
plane	4
play	4, 13
please	17
plum	6
police officer	7
police station	12
post office	14
potatoes	9
pull	16
purse	1
push	16
quarter	18
railway station	14
read	17
receptionist	7
red	14
restaurant	2
rice	9
right	14
road	12
roof	14
room	13
run	4
sad	18
sales assistant	7
sandwich	6
Saturday	8
sausage	6
school	8
seat	4

second	14, 19
secretary	3
See you later	11
sell	16
September	8
seven	6
seventeen	8
seventh	14
seventy	12
she	2
shoe	4
shop	17
short	9, 17
shoulder	11
since	8
sister	1
sit	4
six	6
sixteen	8
sixth	14
sixty	12
sleep	16
slowly	7
small	9
sock	6
some	6
something to drink	6
something to eat	6
son	1
Sorry, I can't	2
Sorry	11
speak	17
stadium	14
stars	11
still	8
stomach	11
stomachache	11
stop	11

straight ahead	14
street	12
sugar	6
suitcase	9
sun	11
Sunday	8
supermarket	14
sure	2
surfboard	9
swim	17
tablet	6
take	2
take a message	17
talk	16
tall	9
taxi driver	7
taxi rank	14
tea	6
teach	16
teacher	3
telephone	17
television	17
ten	6
tennis	17
tenth	14
Thank you	1
Thanks for coming	11
that	3
That'd be great	2
That's OK	13
the	1
theater	2
their	1
them	2
there	3
these	3
they	2
think	9

third	14
thirteen	8
thirty	12
thirty-one	12
this	1
this is	1
those	3
three	6
Thursday	8
ticket	6
timetable	19
to	2, 7
today	18
toilet	14
tomato	9
tomorrow	18
too	7
tooth	11
toothache	11
toothbrush	13
toothpaste	13
tour guide	7
traffic lights	14
train	8
trumpet	13
tube	13
Tuesday	8
turn	14
twelve	8
twenty	8
twenty-eight	12
twenty-five	12
twenty-four	12
twenty-nine	12
twenty-one	12
twenty-seven	12
twenty-six	12
twenty-three	12



twenty-two	12
two	6
two hundred and one	12
us	2
use	19
very	9
very much	9
view	4
violin	13
wait	13
waiting room	13
wall	13
wallet	1
was	7, 16
wash	16
watch	1, 17
watch	17
water	6
we	2
wedding	18
Wednesday	8
week	8
weekend	8
welcome	18
well	4
were	3, 16
wet	4
what	1
What do you do?	7
What do you think?	9
What would you like?	6
What's the matter?	11
What's the time?	18
What's wrong?	11
What's your address?	12
What's your name?	1
when	7
where	7

Where are you from?	8
Where do you live?	12
white	14
who	2
Who's calling?	17
whose	1
wide	9
wife	1
will	12
window	13
with	14
work	4, 17
worried	18
would be nice	6
Would you like to come to?	2
Would you like	6
write	16
year	8
yellow	14
yes	1
Yes, please	6
yesterday	18
you	2
You should	13
You're not allowed to	9
your	1
yours	4

## Other books of interest from Tuttle Publishing

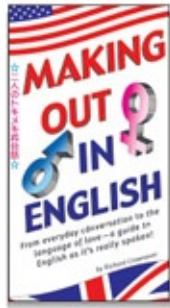

ISBN 978-0-8048-3681-4

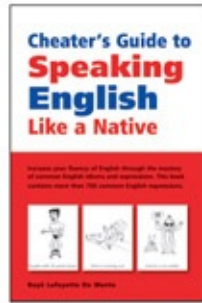

ISBN 978-0-8048-3682-1

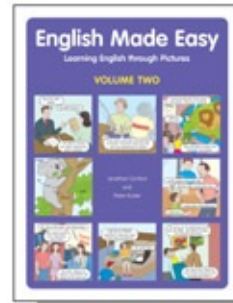

ISBN 978-0-8048-3745-3



# Other Ebooks Available

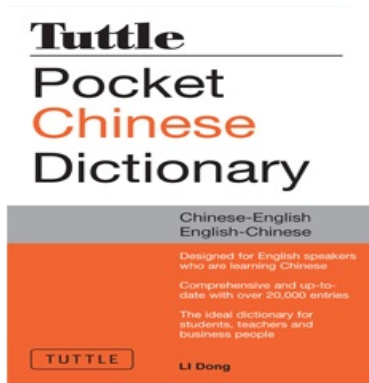

ISBN: 978-1-4629-1090-8

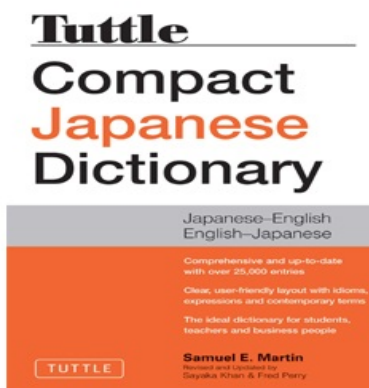

ISBN: 978-1-4629-1082-3

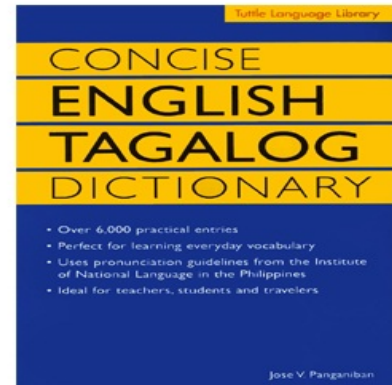

ISBN: 978-1-4629-1128-8

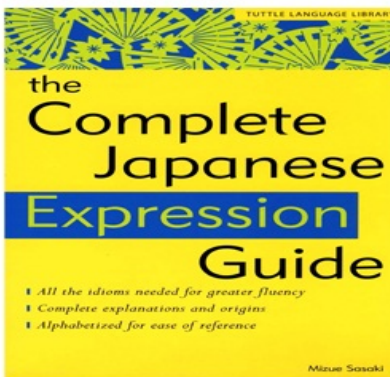

ISBN: 978-1-4629-0469-3

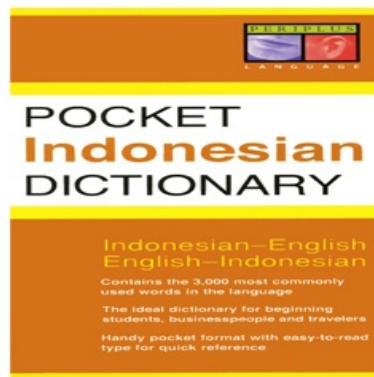

ISBN: 978-1-4629-0981-0

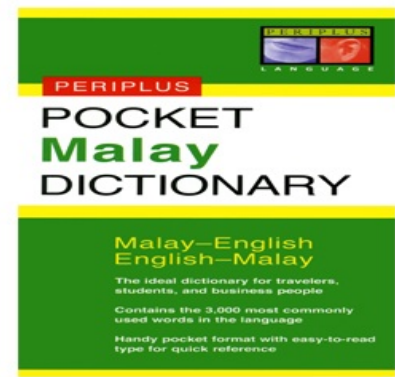

ISBN: 978-1-4629-0982-7

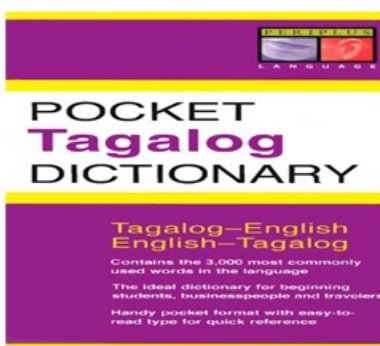

ISBN: 978-1-4629-0983-4

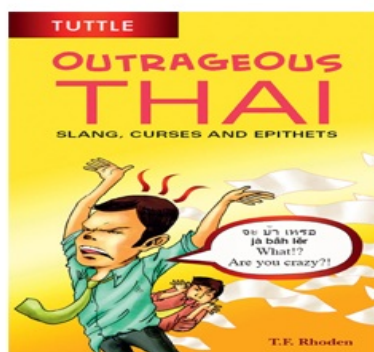

ISBN: 978-1-4629-1031-1



ISBN: 978-1-4629-1057-1



**English Made Easy** is a breakthrough in English language learning—imaginatively exploiting how pictures and text can work together to create understanding and help learners learn more productively. It gives learners easy access to the vocabulary, grammar and functions of English as it is actually used in a comprehensive range of social situations. Self-guided students and classroom learners alike will be delighted by the way they are helped to progress easily from one unit to the next, using a combination of pictures and text to discover for themselves how English works. The pictorial method used in this book is based on a thorough understanding of language structure and how language is successfully learned. The authors are experienced English language teachers with strong backgrounds in language analysis and language learning.

**English Made Easy: Learning English through Pictures Volume 1** consists of a total of 20 units arranged in groups of five. The first four units present language and provide learners the opportunities to practice as they learn. The first page of each unit has a list of all the words and phrases to be learned in that unit, together with a pronunciation guide. At the end of each unit, an interesting story which uses the language that has just been learned is presented. The fifth unit in each group contains exercises designed to reinforce the language learned in the first four units.

TUTTLE

[www.tuttlepublishing.com](http://www.tuttlepublishing.com)

Printed in Singapore

ISBN 978-1-4629-0557-7



9 781462 905577 US \$19.95

